

Catalogo Generale . General Catalogue



MINIPRESS
DIAGNOSTIC SYSTEMS

Prevenire è meglio che curare. Parola di Mini Press.

Mini Press è nata nel 1991 con un obiettivo chiaro e preciso: risolvere il problema del controllo della pressione e del monitoraggio dei fluidi negli impianti oleodinamici.

Dopo una lunga esperienza nel settore, Dario Corsi, fondatore dell'Azienda, ha affrontato una delle principali cause di inefficienza del macchinario mobile: il buon funzionamento di macchine estremamente complesse e costose poteva essere ostacolato da un banale problema di riduzione o modificazione della pressione dei fluidi. La soluzione più ovvia, ma non per questo la più scontata, è stata quella di mettere a punto uno specifico sistema diagnostico che potesse garantire, in qualsiasi momento, luogo e condizione (anche la più estrema), la verifica immediata della pressione all'interno dell'impianto, senza interromperne l'attività. In più di venticinque anni di attività, Mini Press, perfezionando il proprio sistema diagnostico, ha saputo raccogliere l'attenzione e il favore dei costruttori più accorti diventando, nel settore, uno dei principali e più qualificati produttori al mondo.



Dario e Davide Corsi

Il sistema Mini Press, impiantato all'origine, offre la migliore garanzia di efficienza, sicurezza e durata per tutte le macchine su cui viene installato.

Se la migliore cura è la prevenzione, i prodotti ed il sistema diagnostico di Mini Press sono un'ottima soluzione per evitare inconvenienti di funzionalità e costosi interventi di riparazione elevando, contemporaneamente, lo standard qualitativo e prestazionale delle vostre macchine.

Prevention is better than cure. The Mini Press philosophy.

Mini Press aim and mission, ever since it was founded in 1991, has been one and one only: solving the problem of pressure control and monitoring fluids inside hydraulic systems.

After a life long experience in the field, Mr. Dario Corsi, the company founder, decided to tackle one of the most common causes of mobile machineries inefficiency: the proper functioning of even the most complex and expensive machines could be thwarted or hindered by a sudden and simple reduction or change in the fluid pressure. The most obvious solution to this problem, but not the simplest, was to create a specific testing system that would allow the immediate control of the pressure inside the machine, without stopping its functioning, at any moment of the working process, in any piece, or under any conditions (even the most extreme). In more than twentyfive years of activity, Mini Press has been able to establish itself as one of the major and most qualified producers of hydraulic testing equipment in the world. All of this was achieved through hard work at refining and improving its testing system, and by catching the attention and finding favour with the most attentive and significant manufacturing companies. Mini Press testing method, devised in-house, guarantees efficiency, safety and endurance for all the machines to which it is installed at construction.

If prevention is always better than cure, Mini Press products and diagnostic testing method are excellent for avoiding any future malfunctioning and expensive repairs and at the same time they can increase the quality and the performance of your machines.

Qualità, efficienza e rapidità delle forniture.

Il nuovo "quartier generale" di Mini Press si sviluppa nella provincia bolognese, in Emilia, nel cuore della "valle dell'oleodinamica" italiana. L'organizzazione si è qui dotata di nuove tecnologie produttive e di controllo ad altissima qualità che, unitamente all'esperienza maturata nel tempo, le permettono di offrire un prodotto e un servizio apprezzati in tutto il mondo. La soddisfazione del cliente è da sempre, il nostro obiettivo primario. E' per questo motivo che oggi, chiunque ci conosca, sa che Mini Press non è solo un ottimo produttore di sistemi diagnostici ma, un vero e proprio partner commerciale sul quale contare.

Quality, efficiency and speed in supplying.

Mini Press new "headquarters" are based in Bologna area, located in Emilia, the heart of the Italian "hydraulic valley". The new location is equipped with the latest technologies for production and the highest quality control. All of this, along with the experience gained over the years, enables Mini Press to offer products and service valued worldwide. Customer's satisfaction has always been our main aim and whoever knows us is well aware that not only are we excellent producers of pressure testing systems but also a true business partner, on whom rely on.



“Rapid System”, perfetto sistema di diagnostica per impianti oleodinamici.

Con tutta l'esperienza e il know-how di cui dispone, Mini Press ha messo a punto **“Rapid System”**, una gamma completa di componenti miniaturizzati che consentono di monitorare ogni singolo sistema, localizzando tempestivamente il problema e impedendo l'insorgenza di altre complicazioni. **“Rapid System”** può essere utilizzato nelle fasi di collaudo, nelle operazioni di spurgo, di prelievo di campioni di fluido, nella manutenzione e nell'assistenza senza interrompere l'attività dell'impianto. Il sistema, riducendo notevolmente gli interventi sulle macchine, permette un considerevole risparmio di tempo e risorse, aumentando nel contempo la sicurezza per l'utilizzatore finale. **“Rapid System”** è l'unica soluzione che, al momento, permette un controllo realmente affidabile degli impianti oleodinamici, incrementando il valore intrinseco delle macchine su cui viene installato.

“Rapid System”, the perfect diagnostic system for hydraulic plants.

With all its experience and know-how, Mini Press created and finely turned **“Rapid System”**, a complete range of miniaturized components which allow a constant monitoring and immediate control on any hydraulic equipment. By localizing immediately any problem in the system it avoids any further complications. **“Rapid System”** can be used at any time during the phases of testing, bleeding, fluid sampling, maintenance and assistance, without stopping the functioning on the plant. Thus reducing the amount of time and resources spent on servicing the machines, and at the same time further insures the operators' safety. **“Rapid System”** is the only solution that enables a reliable and effective control of hydraulics plants and at the same time increases the intrinsic value of the machine to which it is installed.

A disposizione di un mondo di costruttori.

I prodotti e i sistemi Mini Press possono essere applicati a qualsiasi tipo di macchinario mobile. Una fitta rete di rivenditori può garantire la fornitura alle Aziende costruttrici di tutti i principali settori (agricolo, industriale, edile e dei trasporti) e in tutti i paesi del mondo. L'incredibile rapporto costo/benefici dei prodotti Mini Press può mettere qualsiasi costruttore nelle condizioni di elevare notevolmente gli standard qualitativi e di sicurezza delle proprie macchine.

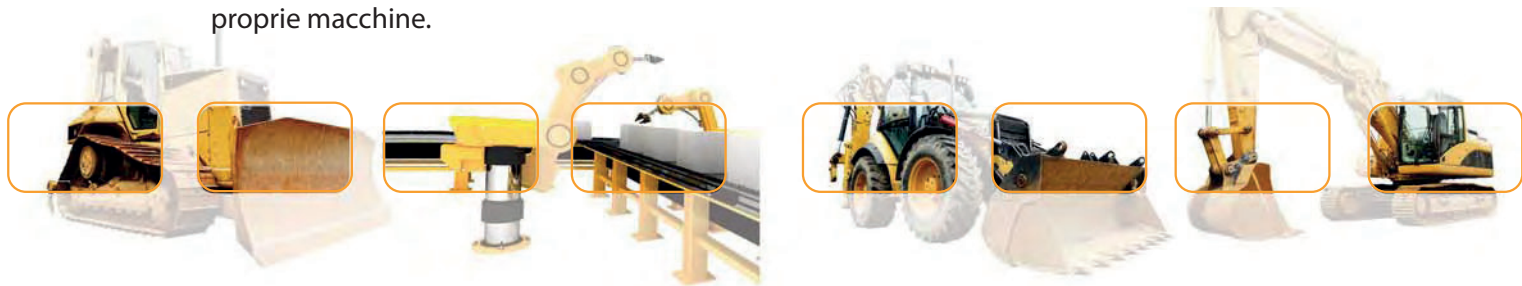

At the Manufacturer's service.

Mini Press products and systems can be applied to any type of mobile machine. With our comprehensive distribution network, we can supply everywhere in the world, in all the main sectors: agricultural, industrial, building construction or transport and in each sector the manufacturer can increase the quality and safety of their machines, thanks to the amazing cost/benefits ratio of our products.

I nostri prodotti. Our products.



Miniprese prova pressione

Test couplings for pressure control



Tubo capillare alta pressione e raccordi

High pressure micro-hose and fittings



Strumenti di controllo digitali

Digital instruments for pressure testing



Strumenti portatili prova pressione

Portable pressure test kits



Manometri

Pressure gauges



Rubinetti esclusori per protezione manometro

Isolator valves for gauges protection



Misuratori di portata in linea

High pressure in-line flow indicators



Pressa pneumo-idraulica per microtubi

Pneumo-hydraulic crimping machine for microhoses

Mini Press nel mondo.

Mini Press fornisce ed assiste i propri clienti, direttamente o attraverso concessionari di fiducia, nei principali mercati a livello mondiale, esportando in più di 50 paesi. Ci contatti per ottenere maggiori informazioni in merito alla gestione del suo paese di provenienza.

Mini Press worldwide.

Mini Press supply products and assistance to its customers in the main markets around the world, directly or through appointed agents and distributors, exporting in more than 50 countries.

Contact us to get more information, we are glad to assist you.

- 2 ► **Miniprese prova pressione**
Test couplings for pressure checking



- 16 ► **Tubo capillare per alta pressione e raccordi**
Micro hose for high pressure and fittings



- 35 ► **Strumenti di controllo digitali**
Digital instruments for pressure testing



- 37 ► **Strumenti portatili prova pressione**
Portable hydraulic instruments for pressure testing



- 39 ► **Manometri**
Pressure gauges



- 40 ► **Rubinetti esclusori protezione manometro**
Pressure gauge isolator valves

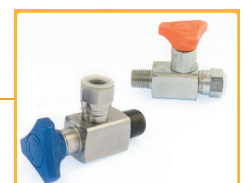

- 42 ► **Misuratori di portata in linea**
High pressure in-line flow indicators



- 43 ► **Pressa pneumo-idraulica per microtubi**
Pneumo-hydraulic crimping machine for microhoses



Applicazioni:

- Controllo pressione
- Lubrificazione
- Spurgo aria
- Prelievo campioni olio

Applications:

- Pressure control
- Lubrification
- Air bleeding
- Oil sampling

Fluidi:

- Olio idraulico
- Olio a base minerale
- Compatibilità con altri fluidi a richiesta
- Compatibilità con azoto a richiesta

Fluids:

- Hydraulic oils
- Mineral oils
- Suitability with other fluids on request
- Suitability with Nitrogen on request

Range di Temperatura / Temperature Range

Materiale tenuta / Sealing material	Materia prima / Raw material	Materia prima / Raw material
	AVP / Carbon steel (11SMnPb37)	Acciaio inossidabile (AISI316L) / Stainless Steel (AISI 316L)
NBR (Nitrile Buna-N)	-25°C / +120°C	-25°C / +120°C
EPDM	-25°C / +130°C	-40°C / +130°C
FKM	-20°C / +200°C	-20°C / +200°C

Esecuzione dei fori filettati e tipi di tenuta
Hole screw-cuts and sealing types
Type A

Tenuta con O-Ring O-Ring sealing	G	D	L	L1
M 8x1		9.5	11	15.5
M 10x1		11.5	12	16.5
M 10x1.25		11	12	16.5
M 14x1.5		15.8	12	18

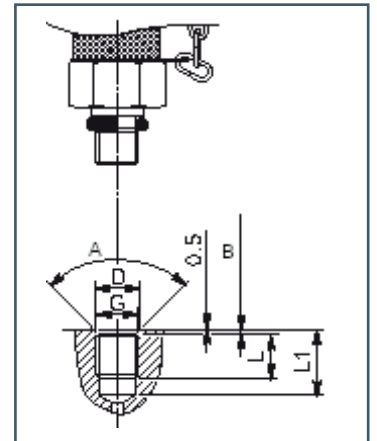
Type B

Tenuta con spigolo metallico di incisione Metal sealing edge	G	Dmin	Lmin	L1min	Smax
M 8x1		13	8	10	1
M 10x1		15	8	10	1
M 12x1.5		18	12	15	1.5
M 14x1.5		20	12	15	1.5
M 16x1.5		23	12	15	1.5
M 18x1.5		25	12	15	2
M 20x1.5		27	14	17	2
M 22x1.5		28	14	17	2.5
M 27x2		33	16	20	2.5
ISO 228 G 1/8"		15	8	10	1
ISO 228 G 1/4"		20	12	15	1
ISO 228 G 3/8"		23	12	15	2
ISO 228 G 1/2"		28	14	18	2.5
ISO 228 G 3/4"		33	16	20	2.5

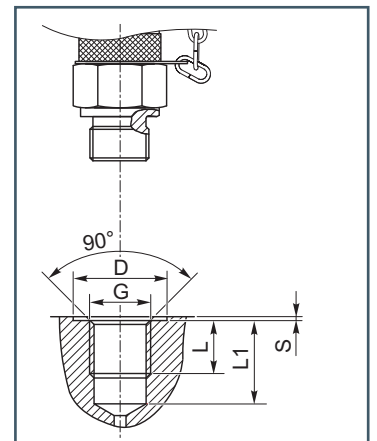



Type **C**

Tenuta con guarnizione piana
Flat gasket sealing

G	D	L	L1	S
M 10x1	15	8	10	1
M 10x1,25	15	8	10	1
M 12x1.5	18	12	15	1.5
M 14x1.5	20	12	15	1.5
M 16x1.5	23	12	15	1.5
ISO 228 G 1/8"	15	8	10	1
ISO 228 G 1/4"	20	12	15	1.5
ISO 228 G 3/8"	23	12	15	2
ISO 228 G 1/2"	28	14	18	2.5

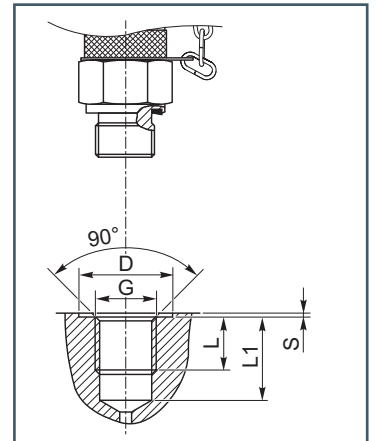

Type **D**

Tenuta:
- Gas conico ISO 7/1
- Conico NPTF

Sealing by thread:
- B.S.P. Taper ISO 7/1
- Taper NPTF

G	L	L1
ISO 7/1 1/8"	5.5	8.5
ISO 7/1 1/4"	8.5	12.5
ISO 7/1 3/8"	8.5	12.5
1/8"-27 NPTF	9	14
1/4"-18 NPTF	9	18.5
3/8"-18 NPTF	14	20
1/2"-14 NPTF	18	24

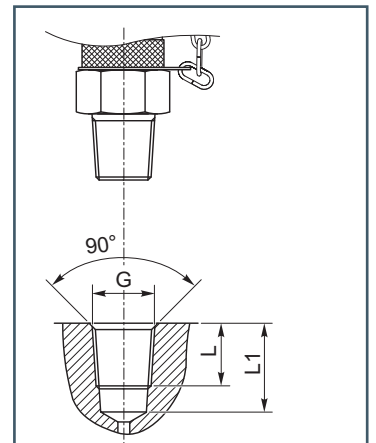

Type **E**

Tenuta con O-Ring
O-Ring sealing

G	d	D	L	L1	S	a
5/16"-24 UNF	9,2	15	11	14	2.4	1.6
3/8"-24 UNF	10,6	16	11	14	2.4	1.6
7/16"-20 UNF	12,4	17	11.5	14	2.4	1.6
1/2"-20 UNF	14	18	11.5	14	2.4	1.6
9/16"-18 UNF	15,6	20	12.7	15.5	2.5	1.6
3/4"-16 UNF	20,5	25	16	20	2.6	2.4
M14X1.5ISO6149	15,8	21	11.5	14	2.4	1.5

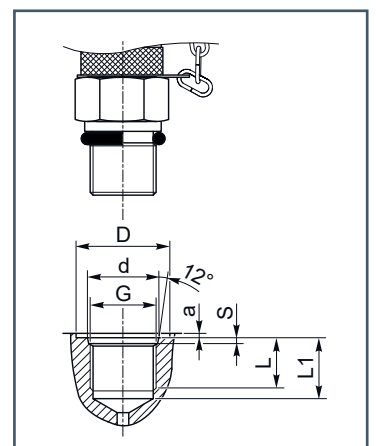



Come ordinare

How to order

Per ordinare i componenti indicare il codice riportato nelle tabelle e modificarlo sulla base delle seguenti opzioni ed indicazioni. Il codice in tabella, nostro standard, descrive articoli in acciaio carbonio con tenute in NBR.

Please indicate the code shown in the provided charts, and modify it, if necessary, on the basis of the following options and indications. The code in the charts, according to our standard configuration, is produced in carbon steel and assembled with NBR sealing.



Opzioni configurazione / Form options

Tappo metallo con catenella e logo Mini Press / Metal cap with chain and Mini Press logo

Lasciare invariato il codice (lettera finale "C") / Do not modify the code (final letter "C") xxxxxxxxxC



Tappo metallo logo Mini Press e laccio in plastica / Metal cap with Mini Press logo and plastic binder

O Sostituire nel codice "C" con "O" / Replace "C" with "O" xxxxxxxxxO



Tappo in plastica / Plastic cap

P Opzione possibile per le filettature M16X2 e M16X1,5 / Possible option for threads M16X2 and M16X1,5

Sostituire nel codice "C" con "P" / Replace "C" with "P" xxxxxxxxxP

Materiale acciaio inossidabile / Stainless steel material

-AI Aggiungere al termine del codice "-AI" / Add at the end of the code "-AI" xxxxxxxxx-AI

Guarnizioni in FKM / FKM sealing

-V Aggiungere al termine del codice "-V" / Add at the end of the code "-V" xxxxxxxxx-V

Guarnizioni in EPDM / EPDM sealing

-E Aggiungere al termine del codice "-E" / Add at the end of the code "-E" xxxxxxxxx-E

Miniprese filettate M 16x2

Threaded test couplings M 16x2

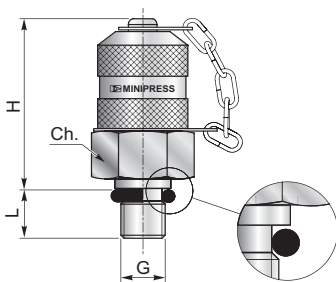

G	H	L	Ch	PN [bar]	Tenuta/Seal	Codice/Ref.
Metrica cilindrica / Metric parallel						
M8x1*	37	8.5	17	400	O-Ring Type A	S10108X10C
M10x1*	37	8.5	17	630		S10110X10C
M10x1.25	37	8.5	17	630		S10110X12C
M14x1.5	37	10	19	630		S10114X15C
ISO 228 JIS 1/4"	37	10	19	630		S10714J00C
Metrica cilindrica / Metric parallel						
7/16"-20UNF*	37	9	17	630	O-Ring Type E	S10171X20C
1/2"-20UNF*	37	10	17	630		S10112X20C
9/16"-18UNF*	37	10	19	630		S10191X18C
3/4"-16UNF	37	14	22	630		S10134X16C
5/16"-24UNF*	37	9	17	630		S10151X24C
3/8"-24UNF	37	9	17	630		S10138X24C
M14x1.5 ISO6149	37	10	19	630		S101146149C

* Disponibili in acciaio inossidabile/ Available in Stainless steel



Minipresa filettata M 16x2

Threaded test coupling M 16x2

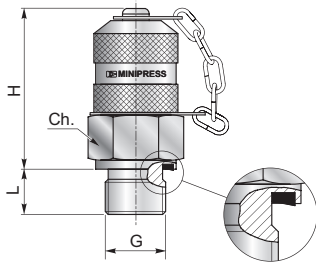

G	H	L	Ch	PN [bar]	Tenuta/Seal	Codice/Ref.
<i>Metrica cilindrica / Metric parallel</i>						
M 10x1*	37	8	17	630	Type C	S10410X10C
M 10x1.25	37	8	17	630		S10410X12C
M 10x1.5	37	12	17	630		S10410X15C
M 12x10	37	12	17	630		S10612X10C
M 12x1.5*	37	12	17	630		S10612X15C
M 14x1.5*	37	12	19	630		S10614X15C
M16x1.5*	37	12	22	630		S10616X15C
<i>Gas cilindrica / B.S.P. parallel</i>						
ISO 228 G 1/8" *	37	8	17	400	Type C	S10718G00C
ISO 228 G 1/4" *	37	12	19	630		S10714G00C
ISO 228 G 3/8" *	37	12	22	630		S10738G00C
ISO 228 G 1/2" *	37	14	27	630		S10712G00C

* Disponibili in acciaio inossidabile/ Available in Stainless steel

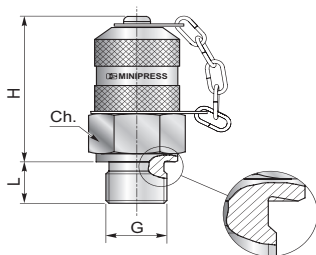

G	H	L	Ch	PN [bar]	Tenuta/Seal	Codice/Ref.
<i>Metrica cilindrica / Metric parallel</i>						
M 8X1	37	8	17	400	Type B	S10308X10C
M 10X1	37	8	17	630		S10310X10C
M 12X1.5	37	12	17	630		S10312X15C
M 14X 1.5	37	12	19	630		S10314X15C
M 16X1.5	37	12	22	630		S10316X15C
M 18X1.5	37	12	27	630		S10318X15C
M 20X1.5	37	14	27	630		S10320X15C
M 22X1.5	37	14	27	630		S10322X15C
M 27X2	37	16	32	630		S10327X20C
<i>Gas cilindrica / B.S.P. parallel - Forma B / Form B</i>						
ISO 228 G 1/8"	37	8	17	400	Type B	S10418G00C
ISO 228 G 1/4"	37	12	19	630		S10414G00C
ISO 228 G 3/8"	37	12	22	630		S10438G00C
ISO 228 G 3/4"	37	16	32	630		S10434G00C
ISO 228 G 1/2"	37	14	27	630		S10412G00C
ISO 228 G 1 1/4"	59.5	20	50	160		S104114G0C
G 1/4" BS5200	37	11	19	630		S10714B00C

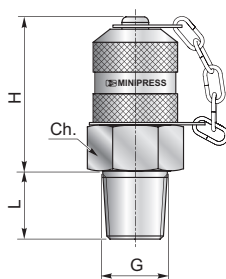

G	H	L	Ch	PN [bar]	Tenuta/Seal	Codice/Ref.
<i>GAS conica / B.S.P tapered</i>						
ISO 7/1 R 1/8" *	37	10	17	400	Type D	S10818280C
ISO 7/1 R 1/4" *	37	12	19	630		S10814190C
ISO 7/1 R 3/8"	37	14	22	630		S10838190C
<i>NPTF / NPTF</i>						
1/8"-27 NPTF*	37	10	17	400	Type D	S10918270C
1/4"-18 NPTF*	37	14	17	630		S10914180C
3/8"-18 NPTF*	37	14	22	630		S10938180C
1/2"-14 NPTF*	37	18	24	630		S10912140C

* Disponibili in acciaio inossidabile/ Available in Stainless steel



Minipresa filettata M 16x1.5

Threaded test coupling M 16x1.5

M 16x1.5

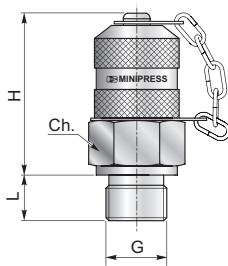

G	H	L	Ch	PN [bar]	Tenuta/Seal	Codice/Ref.
<i>Metrica cilindrica / Metric parallel</i>						
M 8x1	37	8.5	17	400	O-Ring Type	S10108X10150C
M 10x1	37	8.5	17	630	A	S10110X10150C
M 14X1.5	37	12	19	630	Type C	S10614X15150C
7/16"-20UNF	37	9	17	630	O-Ring Type E	S10171X20150C
<i>Gas cilindrica / B.S.P. parallel</i>						
ISO 228 G 1/4"*	37	12	19	630	Type	S10714150C
ISO 228 G 1/8"	37	8	17	630	C	S10718150C
ISO 228 G 1/4"	37	12	19	630	Type B	S10414150C
<i>Gas conica / B.S.P. Tapir</i>						
ISO 7/1 R 1/4"	37	12	19	630	Type D	S10814150C
<i>NPTF / NPTF</i>						
1/4"-18NPTF*	37	14	17	630	Type D	S10914150C

* Disponibili in acciaio inossidabile/ Available in Stainless steel

Minipresa filettata M 12.65x1.5

Threaded test coupling M 12.65x1.5

M 12.65x1.5

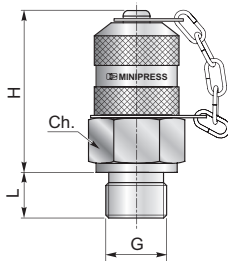

G	H	L	Ch	PN [bar]	Tenuta/Seal	Codice/Ref.
<i>Metrica cilindrica / Metric parallel</i>						
M 8x1	30	8.5	17	400	O-Ring Type	S10108X10120C
M 10x1	30	8.5	17	630	A	S10110X10120C
M 10x1	30	8	17	630	Type	S10410X10120C
M 12x1,5	30	12	17	630	C	S10612X15120C
5/16"-24UNF	30	9	17	630	O-Ring Type	S10151X24120C
7/16"-20UNF	30	9	17	630	E	S10171X20120C
<i>Gas cilindrica / B.S.P. parallel</i>						
ISO 228 G 1/4"	30	12	19	630	Type	S10714120C
ISO 228 G 1/8"	30	8	17	400	C	S10718120C
<i>NPTF / NPTF</i>						
1/4"-18 NPTF	30	14	17	630	Type D	S10914120C



Minipresa a codolo liscio M 16x2

Standpipe test coupling M16X2

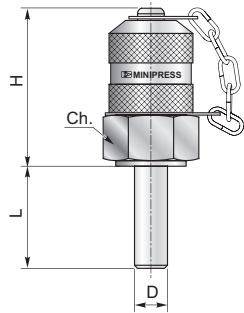

D	H	L	Ch	Codice/Ref.
6*	37	20	17	S11206000C
8	37	20	17	S11208000C
10	37	20	17	S11210000C
12	37	20	17	S11212000C
14	37	20	17	S11214000C
15	37	20	17	S11215000C
16	37	20	17	S11216000C

* Disponibili in acciaio
inossidabile/ Available in
Stainless steel

Minipresa passaparte

Bulkhead test coupling

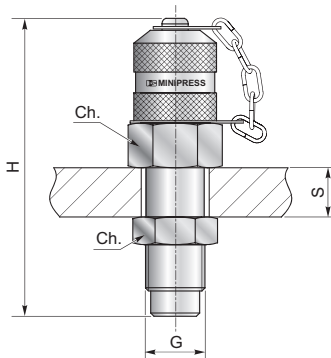

G1	G1	H	Ch	S max	PN [bar]	Codice/Ref.
M 16x2	M 16x2	72	19	25	630	S122PP000C
S12.65x1.5	S12.65x1.5	63	19	12	630	S122PP120C

Minipresa passaparte per tubo metallico M 16x2

Bulkhead test coupling for metal pipe fitting M 16x2

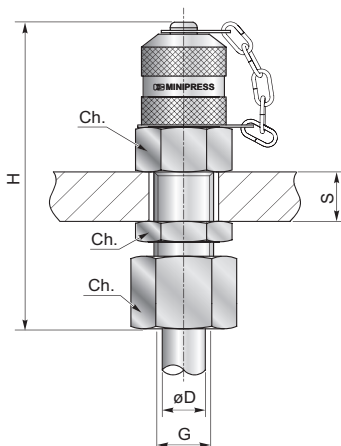

Serie / Series	D	G	H	Ch	Ch 1	S max	PN [bar]	Codice/Ref.
S	8*	M 16x1.5	82	19	19	20	630	S11616X15C
	10	M 18x1.5	81	22	22	20	630	S11618X15C
	12	M 20x1.5	80	24	24	20	630	S11620X15C

* Disponibili in acciaio
inossidabile/ Available in
Stainless steel



Minipresa raccordo intermedio diritto per tubo metallico

Straight test coupling for metal pipe fitting

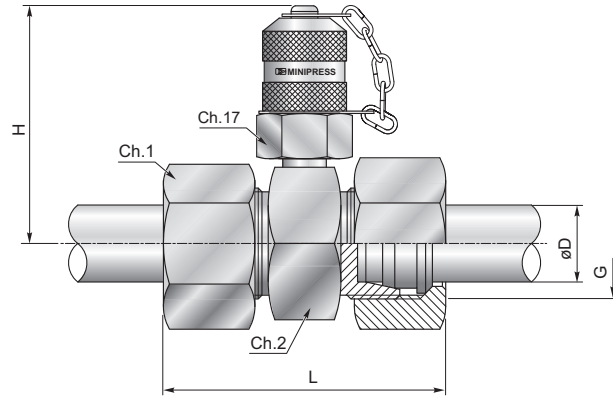

Serie / Series	D	G	H	L	Ch 1	Ch 2	PN [bar]	Codice/Ref.	Codice/Ref.	Codice/Ref.
Raccordi ad anello / Ring fittings								M 16x2*	M 16x1.5	M 12.65x1.5*
L	6	M 12x1.5	48	57	14	24	250	S11306000C	S11306150C	S11306120C
	8	M 14x1.5	48	55	17	24	250	S11308000C	S11308150C	S11308120C
	10	M 16x1.5	48	59	19	24	250	S11310000C	S11310150C	S11310120C
	12	M 18x1.5	48	60	22	24	250	S11312000C	S11312150C	S11312120C
	15	M 22x1.5	50	62	27	27	250	S11315000C	S11315150C	S11315120C
	18	M 26x1.5	52	64	32	32	160	S11318000C	S11318150C	S11318120C
	22	M 30x2	52	70	36	32	160	S11322000C	S11322150C	S11322120C
	28	M 36x2	57	69	41	41	100	S11328000C	S11328150C	S11328120C
	35	M 45x2	59	80	50	46	100	S11335000C	S11335150C	S11335120C
	42	M 52x2	66	79	60	55	100	S11342000C	S11342150C	S11342120C
S	6	M 14x1.5	48	61	17	24	630	S11406000C	S11406150C	S11406120C
	8	M 16x1.5	48	59	19	24	630	S11408000C	S11408150C	S11408120C
	10	M 18x1.5	48	61	22	24	630	S11410000C	S11410150C	S11410120C
	12	M 20x1.5	48	60	24	24	630	S11412000C	S11412150C	S11412120C
	14	M 22x1.5	50	66	27	27	630	S11414000C	S11414150C	S11414120C
	16	M 24x1.5	50	69	30	27	400	S11416000C	S11416150C	S11416120C
	20	M 30x2	52	87	36	32	400	S11420000C	S11420150C	S11420120C
	25	M 36x2	57	86	46	41	400	S11425000C	S11425150C	S11425120C
	30	M 42x2	59	93	50	46	250	S11430000C	S11430150C	S11430120C
	38	M 52x2	63	96	60	55	250	S11438000C	S11438150C	S11438120C

* Per fattibilità e disponibilità in acciaio inossidabile, si prega di verificare con ns ufficio commerciale.
/ Please verify the feasibility and availability of the stainless steel versions with our sales office.

Minipresa filettata M 16x2 a 90°

90° Threaded test couplina M 16x2

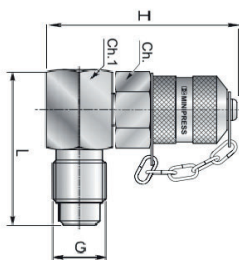

G	L	H	Ch	Ch1	Codice/Ref.
ISO 228 G1/4"	39	55.4	17	19	S10714G90C



Minipressa tipo DKO codolo conico 24° con O-Ring

Test coupling with 24° O-Ring sealing cone DKO type

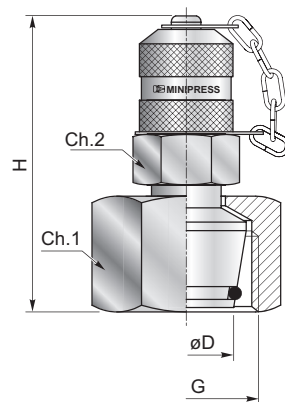

Serie / Series	D	G	H	Ch 1	Ch 2	PN [bar]	Codice/Ref.	Codice/Ref.	Codice/Ref.
							M 16x2*	M 16x1.5	M 12.65x1.5
L	6	M 12x1.5	53	14	17	250	S11012X15C	S11012X15150C	S11012X15120C
	8	M 14x1.5	55	17	17	250	S11014X15C	S11014X15150C	S11014X15120C
	10	M 16x1.5	56	19	19	250	S11016X15C	S11016X15150C	S11016X15120C
	12	M 18x1.5	57	22	19	250	S11018X15C	S11018X15150C	S11018X15120C
	15	M 22x1.5	59	27	22	250	S11022X15C	S11022X15150C	S11022X15120C
	18	M 26x1.5	59	32	22	160	S11026X15C	S11026X15150C	S11026X15120C
	22	M 30x2	57	36	27	160	S11030X20C	S11030X20150C	S11030X20120C
	28	M 36x2	63	41	17	100	S11035X20C	S11035X20150C	S11035X20120C
	35	M 45x2	70	50	17	100	S11045X20C	S11045X20150C	S11045X20120C
S	42	M 52x2	70	60	17	100	S11052X20C	S11052X20150C	S11052X20120C
	6	M 14x1.5	54	17	17	630	S11114X15C	S11114X15150C	S11114X15120C
	8	M 16x1.5	56	19	17	630	S11116X15C	S11116X15150C	S11116X15120C
	10	M 18x1.5	57	22	19	630	S11118X15C	S11118X15150C	S11118X15120C
	12	M 20x1.5	58	24	19	630	S11120X15C	S11120X15150C	S11120X15120C
	14	M 22x1.5	59	27	22	400	S11122X15C	S11122X15150C	S11122X15120C
	16	M 24x1.5	60	30	22	400	S11124X15C	S11124X15150C	S11124X15120C
	20	M 30x2	61	36	27	400	S11130X20C	S11130X20150C	S11130X20120C
	25	M 36x2	69	46	17	400	S11136X20C	S11136X20150C	S11136X20120C
	30	M 42x2	72	55	17	250	S11142X20C	S11142X20150C	S11142X20120C
38	M 52x2	76	60	17	250	S11152X20C	S11152X20150C	S11152X20120C	

* Per fattibilità e disponibilità in acciaio inossidabile, si prega di verificare con ns ufficio commerciale. / Please verify the feasibility and availability of the stainless steel versions with our sales office.

Minipressa di pressione con giunzione diritta 60°

Check coupling male - female swivel 60°

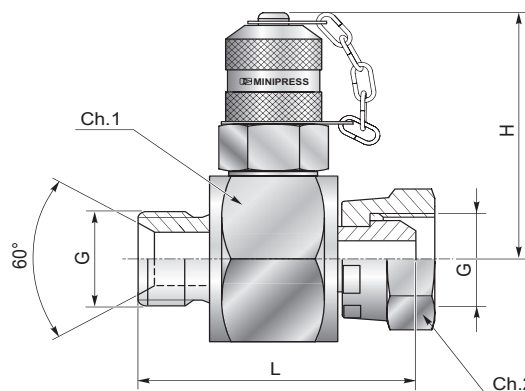

G	H	L	Ch1	Ch2	PN bar	Codice/Ref.	Codice/Ref.	Codice/Ref.
						M 16x2 *	M 16x1.5 *	M 12.65x1.5
ISO 228 G1/4"	51	53	32	19	400	S11914G00C	S11914150C	S11914120C
ISO 228 G3/8"	51	60	32	22	400	S11938G00C	S11938150C	S11938120C
ISO 228 G1/2"	51	60	32	27	400	S11912G00C	S11912150C	S11912120C
ISO 228 G3/4"	51	60	32	32	400	S11934G00C	S11934150C	S11934120C
ISO 228 G1"	56	61	41	41	315	S11901G00C	S11901150C	S11901120C

* Per fattibilità e disponibilità in acciaio inossidabile, si prega di verificare con ns ufficio commerciale. / Please verify the feasibility and availability of the stainless steel versions with our sales office.



Minipresa passaparete JIC 37° M 16x2

Bulkhead test coupling - JIC 37° M 16x2

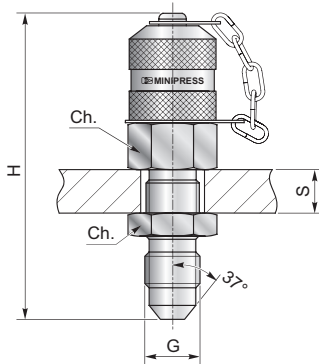

G	H	Ch	S max	PN [bar]	Codice/Ref.
7/16"-20 UNF	67	17	9	630	S11707162C
1/2"-20 UNF	67	17	9	400	S11701220C
9/16"-18 UNF	68	19	9	315	S11709161C

Minipresa con raccordo femmina girevole sede JIC 37° M 16x2

Female swivel test coupling - JIC 37° M 16x2

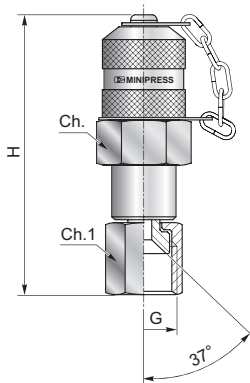

G	H	Ch	Ch 1	PN [bar]	Codice/Ref.
7/16"-20 UNF	57	17	14	630	S11507163C
1/2"-20 UNF	55	17	17	400	S11512203C
9/16"-18 UNF	52	17	17	315	S11509163C
3/4"- 16 UNF	59	19	22	315	S11506163C
7/8"- 14 UNF	64	24	27	315	S11507083C

Minipresa con raccordo femmina fisso sede JIC 37° M 16x2

Female fixed test coupling - JIC 37° M 16x2

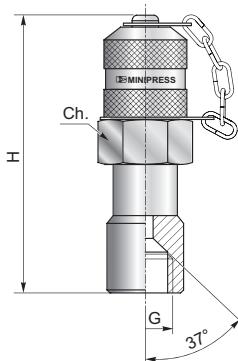

G	H	Ch	PN [bar]	Codice/Ref.
7/16"-20 UNF	63	19	630	S115071FFC
1/2"-20 UNF	63	19	400	S115012FFC
9/16"-18 UNF*	66	19	315	S115091FFC

* Disponibili in acciaio inossidabile/ Available in Stainless steel



Minipresa con raccordo femmina girevole O.R.F.S. M 16x2

O.R.F.S female swivel test coupling M 16x2

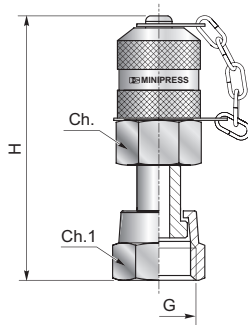

G	H	Ch	Ch 1	PN [bar]	Codice/Ref.
9/16"-18 UNF	60	17	17	630	S115916FSC
11/16"-16 UNF	62	17	22	630	S115116FSC
13/16"-16 UNF	65	19	24	630	S115131FSC

Minipresa di pressione femmina girevole M 16x2

Female swivel check-coupling M 16x2

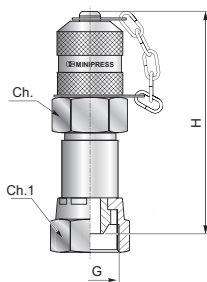

G	H	Ch	Ch 1	PN [bar]	Codice/Ref.
ISO 228 G 1/4"*	54	19	17	400	S115914G0C
ISO 228 G 3/8"	54	19	22	400	S115938G0C

* Disponibili in acciaio inossidabile/ Available in Stainless steel

Minipresa filettata M 16x2 con dado forato

Threaded test coupling M 16x2 banjo screw

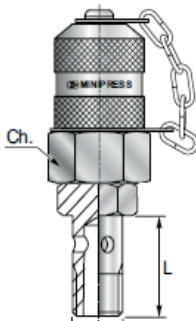

G	H	L	Ch	PN [bar]	Codice/Ref.
ISO 228 G 1/4"	60	26	19	630	S142R2HS0C

Innesto rapido + minipresa 15QC000C

Test quick coupling + test point 15QC000C



Innesto rapido femmina: innestandolo sul maschio consente il controllo dei parametri della pressione dell'olio in un impianto oleodinamico. Si adatta al sistema di misurazione Mini Press, grazie ad una minipresa con filetto di uscita M 16x2 per attacco a microtubo raccordato o portamanometro, avvitata su di esso.

Female quick coupling: coupling it with the male part to control the parameters of pressure in the hydraulic systems. It has been adapted to the Mini Press diagnostic system through a test coupling male threaded M16X2 (to be connected to a hose assembly or a gauge adapter), screwed on it.

Norma: ISO 15171-2

Applicazione: diagnostica impianti oleodinamici

Pressione di esercizio: 400 bar

Materiale: acciaio zincato

Tenuta: NBR

Norm: ISO 15171-2

Application: diagnostic on hydraulic systems

Working pressure: 400 bar

Material: zinc steel

Seal: NBR



Minipresa con innesto a baionetta

Plug-in test coupling

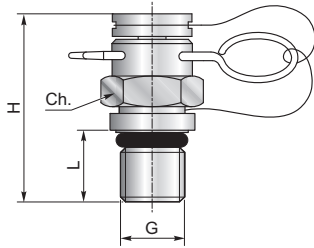

G	H	L	Ch	PN [bar]	Tenuta/Seal	Codice/Ref.
Filettatura: metrica cilindrica / Thread: metric parallel (UNI 4535-64)						
M 8x1	26	8.5	12	250	O-Ring type A	51000000
M 10x1	26	8.5	14	400		51100000
ISO 228 G1/4"	34	12	19	400	Metal Sealing Edge B	5114G000

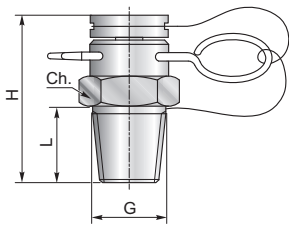

G	H	L	Ch	PN [bar]	Tenuta/Seal	Codice/Ref.
Filettatura: gas conica / Thread: B.S.P. taper (UNI ISO 7/1)						
ISO 7/1 R1/8"	26	10	12	400	Type D	51800000
Filettatura: gas conica / Threaded: B.S.P. taper NPTF (ANSI/ASME B.1.20.1 - 1983)						
1/8" NPTF	26	10	12	400	Type D	51900000

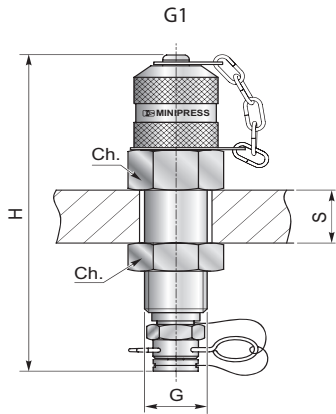

G1	H	Ch	S max	PN [bar]	Codice/Ref.
Minipresa passaparete / Bulkhead test coupling					
M 16x2	86.5	19	25	400	S123PPIB0C

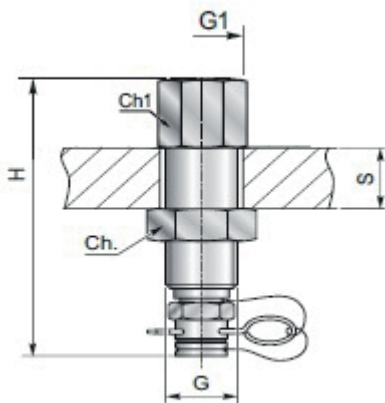

G1	H	Ch	Ch1	S max	PN [bar]	Codice/Ref.
ISO 228 G1/4" #	63	19	19	25	400	1814000B
ISO 228 G1/2" #	72	19	27	25	400	1812000B

#Tenuta per manometro
con o-ring/
gauge sealing with o-ring



Minipressa con innesto a baionetta tipo DKO codolo conico 24° con O-Ring

Plug-in test coupling with 24° O-Ring sealing cone DKO type

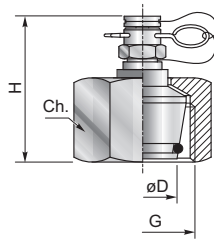

Serie / Series	D	G	H	Ch	PN [bar]	Codice/Ref.
L	8	M 14x1.5	39	17	250	1014X15B
	10	M 16x1.5	39	19	250	1016X15B
	12	M 18x1.5	39	22	250	1018X15B
	15	M 22x1.5	39	27	250	1022X15B
	18	M 26x1.5	39	32	160	1026X15B
	22	M 30x2	39	36	160	1030X20B
	28	M 35x2	40	41	100	1035X20B
	35	M 45x2	42	50	100	1045X20B
S	42	M 52x2	45	60	100	1052X20B
	10	M 18x1.5	39	22	630	1118X15B
	12	M 20x1.5	39	24	630	1120X15B
	14	M 22x1.5	39	27	400	1122X15B
	16	M 24x1.5	40	30	400	1124X15B
	20	M 30x2	42	36	400	1130X20B
	25	M 36x2	44	46	400	1136X20B
	30	M 42x2	44	50	250	1142X20B
38	M 52x2	44	60	250	1152X20B	

Minipressa a baionetta raccordo intermedio diritto per tubo metallico

Plug-in straight test coupling for metal pipe fitting

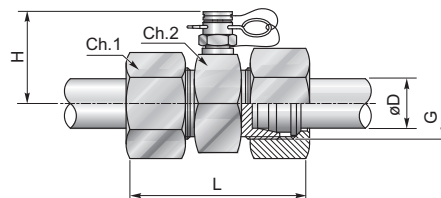

Serie / Series	D	G	H	L	Ch 1	Ch 2	PN [bar]	Codice/Ref.
Raccordi ad anello / Ring fittings								
L	6	M 12x1.5	29	51	14	24	315	1306000B
	8	M 14x1.5	29	51	17	24	315	1308000B
	10	M 16x1.5	29	53	19	24	315	1310000B
	12	M 18x1.5	29	53	22	24	315	1312000B
	15	M 22x1.5	30.5	55	27	27	315	1315000B
	18	M 26x1.5	33	57	32	32	315	1318000B
	22	M 30x2	33	61	36	32	160	1322000B
	28	M 36x2	37.5	61	41	41	160	1328000B
	35	M 45x2	40	69	50	46	160	1335000B
	42	M 52x2	44.5	71	60	55	160	1342000B
S	6	M 14x1.5	29	55	17	24	630	1406000B
	8	M 16x1.5	29	55	19	24	630	1408000B
	10	M 18x1.5	29	57	22	24	630	1410000B
	12	M 20x1.5	29	57	24	24	630	1412000B
	14	M 22x1.5	29	63	27	24	630	1414000B
	16	M 24x1.5	32	63	30	27	400	1416000B
	20	M 30x2	33	69	36	32	400	1420000B
	25	M 36x2	37.5	75	46	41	400	1425000B
	30	M 42x2	40	81	50	46	400	1430000B
	38	M 52x2	44.5	89	60	55	315	1438000B



Adattatori per manometro

Pressure gauge adapters

Opzioni / Options

Smorzatore di pressione a richiesta / Pressure damper on request

Opzione non prevista per tutte le tipologie / This option is not provided for all the models

S

Sostituire la lettera S allo 0
Replace "0" with "S"

xxxxxxxS

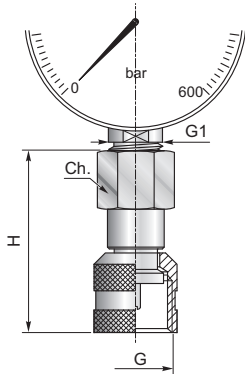

G	G1	H	Ch	PN [bar]	Codice/Ref.
Porta manometro connessione diretta / Direct gauge adapter					
M 16x2	ISO 228 G 1/8"	50	17	630	20180000
M 16x2*#	ISO 228 G 1/4"	50	19	630	20140000
M 16x2*#	ISO 228 G 1/2"	55	27	630	20120000
M 16x1.5*#	ISO 228 G 1/4"	50	19	630	20141500
M 16x1.5	ISO 228 G 1/2"	55	27	630	20121500
M12.65x1.5	ISO 228 G 1/4"	43	19	630	20141200
S12.65x1.5	ISO 228 G 1/2"	48	27	630	20121200
M 16x2*	1/4" - 18 NPTF	51.5	19	630	2014NPT0
M12.65x1.5	1/4" - 18 NPTF	50	19	630	201412NPT

* Disponibili in acciaio inossidabile / Available in Stainless steel

#Disponibile tenuta per sensore o manometro digitale / Available sensor or digital gauge sealing

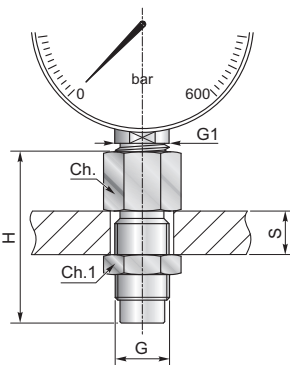

G	G1	H	Ch	Ch 1	S max	PN [bar]	Codice/Ref.
Porta manometro passaparete / Bulkhead pressure gauge connection							
M 16x2*	ISO 228 G 1/4"	46	19	19	11	630	18140000
M 16x2*	ISO 228 G 1/2"	57	27	19	13	630	18120000
M 16x1.5	ISO 228 G 1/4"	46.5	19	19	11	630	18141500
M 12.65x1.5	ISO 228 G 1/4"	52.5	19	19	11	630	18141200
M 16x1.5	ISO 228 G 1/2"	57	27	19	13	630	18121500
M 12.65x1.5	ISO 228 G 1/2"	57	27	19	13	630	18121200
M 16x2*	1/4" - 18 NPTF	48	19	19	11	630	1814NPT0

* Disponibili in acciaio inossidabile / Available in Stainless steel

N.B. : passaggio libero senza valvola / Please note: free passage, without check valve

Opzioni/Options

S

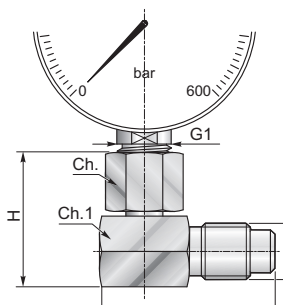

G	G1	H	L	Ch	Ch 1	PN [bar]	Codice/Ref.
Porta manometro orientabile 90° / Swivel pressure gauge connection 90° angle							
M 16x2	ISO 228 G 1/4"	36	42	19	19	630	21140000
M 16x2	ISO 228 G 1/2"	44	42	27	19	630	21120000
M 16x1.5	ISO 228 G 1/4"	36	42	19	19	630	21141500
M 16x1.5	ISO 228 G 1/2"	44	42	27	19	630	21121500

N.B. : passaggio libero senza valvola / Please note: free passage, without check valve

Opzioni/Options

S

Adattatori

Adapters

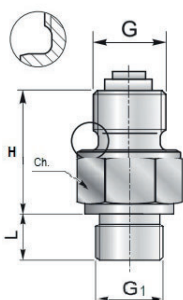

G	G1	H	L	Ch	PN [bar]	Codice/Ref.
ISO 228 G 1/4" #	ISO 228 G 1/4" 60°	33.5	11	17	630	251414MZ
ISO 228 G 1/4" #	ISO 7/1 1/4"	36.5	12	17	630	2514RG00

#Filetto maschio come manometro analogico / analog male gauge sealing



Adattatori

Adapters

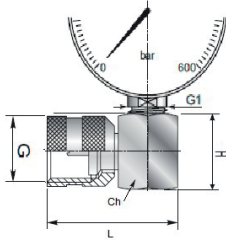

G	G1	H	L	Ch	PN [bar]	Codice/Ref.
Porta manometro fisso 90° / Pressure gauge connection 90° angle						
M 16x2	ISO 228 G 1/2"	38	51	27	630	24GG12F001

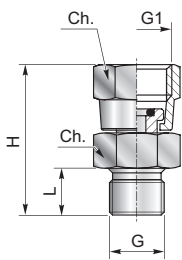

G	G1	H	L	Ch	PN [bar]	Tenuta/Seal	Codice/Ref.
Adattatore per manometro / Gauge adapter							
ISO 228 G 1/4"	ISO 228 G 1/4"*	37	12	17	400	*	1814M000
ISO 228 G 1/2"	ISO 228 G 1/2"*	52	14	27	400	*	1812M000
ISO 228 G 1/4"	ISO 228 G 1/2"	49	12	27	400	*	1812M140
ISO 228 G 1/4"	ISO 228 G 1/8"	37	12	19	400	*	1814M700
ISO 7/1 R 1/4"	ISO 228 G 1/4"*	35	12	17	400	*	1814MBSPT
ISO 7/1 R 1/2"	ISO 228 G 1/2"*	52	16	27	400	*	1812MBSPT
ISO 7/1 R 1/4"	ISO 228 G 1/2"*	46.5	12	22	400	*	1824MBSPT
ISO 228 G 3/8"	ISO 228 G 1/2"	49.5	12	27	400	*	1812M380

* Disponibili in acciaio inossidabile / Available in Stainless steel

Rondella di rame per tenuta filetto maschio su richiesta / Copper washer for male thread sealing on request

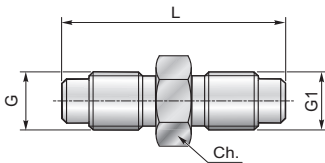

G	G1	L	Ch	PN [bar]	Codice/Ref.
Adattatore diretto per giunzione tubi. Passaggio libero Straight adapter for connection of hoses. Free passage					
M 16x2	M 16x2	48	17	630	40GD0000
M 16x1.5	M 16x2	48	17	630	40GD1500
M 16x1.5*	M 16x1.5	48	17	630	40GD1515

* Disponibili in acciaio inossidabile / Available in Stainless steel

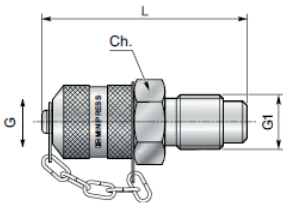

G	G1	L	Ch	PN [bar]	Codice/Ref.
Adattatore diretto con valvola di non ritorno / Straight adapter with non-return valve					
M 16x2	M 16x2	57	17	630	41GV000C

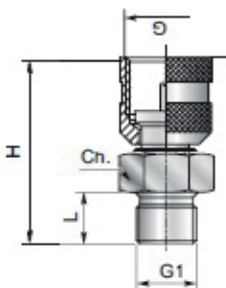

G	G1	H	L	Ch	PN [bar]	Codice/Ref.
Adattatore minipressa. Passaggio libero / Test coupling adapter. Free passage						
M 16x2	ISO 228 G 1/4"	48	12	19	400	23GG1400
M 16x1.5	ISO 228 G 1/4"	48	12	19	400	23GG1415

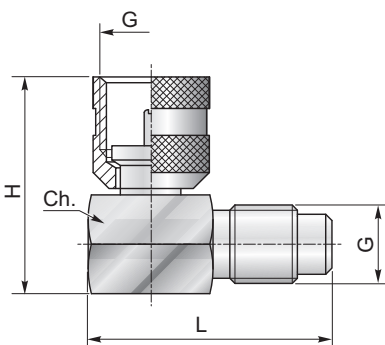

G	H	L	Ch	PN [bar]	Codice/Ref.
Adattatore minipressa 90°. Passaggio libero / 90° Test coupling adapter. Free passage					
M 16x2	45	42	19	630	24GG0000
M 16x1.5	45	42	19	630	24GG1500
Opzione con valvola a pistone su filetto maschio / Option with poppet valve in male thread					
M 16x2	45	42	19	630	S124GG0000
M 16x1.5	45	42	19	630	S124GG1500

Come ordinare un tubo raccordato
How to order a hose assembly

Codice ordine / Order code			
RD2	31TTN000	36140000	L1500

- 1** Tipologia di tubo / hose type
- 2** Codice raccordo 1 * / Fitting 1 part number *
- 3** Codice raccordo 2 * / Fitting 2 part number *
- 4** Lunghezza tubo in mm / Hose length in mm **

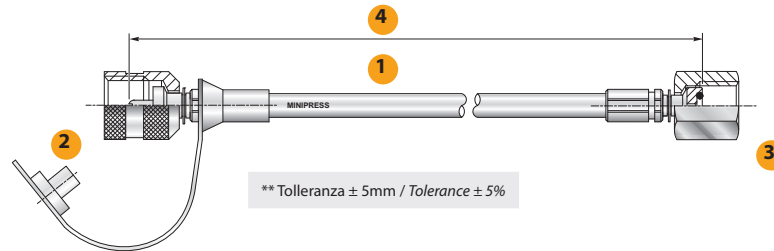

* I codici indicati nelle tabelle del catalogo, secondo nostro standard, descrivono articoli in acciaio carbonio con tenute in NBR. Per differenti opzioni si veda la pagina seguente / The codes in the catalogue's charts, according to our standard configuration, are produced in carbon steel and assembled with NBR sealing. For different options please refer to the following page.

Configurazione tubo raccordato standard Per tipologie di raccordi e lunghezze differenti si prega di contattare il ns ufficio commerciale

Hose assembly standard configuration For different fittings and lengths please contact our sales office

Scelta della tipologie di tubo / Choose the hose type		
RD2	RD3	RD4
Opzione standard 1: ambo i lati raccordo femmina dritto M16X2 / Standard option 1: both ends straight female fitting M16X2		
31TTN000 - 31TTN000	31TTN003 - 31TTN003	31TTN004 - 31TTN004
Opzione 2: raccordo femmina dritto M16X2 + femmina dritto 1/4" per manometro analogico / Option 2: straight female fittings M16X2 + straight female 1/4" per analog gauge		
31TTN000 - 36140000	31TTN003 - 3614OR03	31TTN004 - 3614OR04
Opzione 3: raccordo ambo i lati femmina dritta M16X1,5 / Option 3: both ends straight female fitting 16X1,5		
31TTS000 - 31TTS000	31TTS003 - 31TTS003	31TTS004 - 31TTS004
Opzione 4: ambo i lati raccordo femmina dritto M12,65X1,5 / Option 4: both ends straight female fitting M12,65X1,5		
31S12000 - 31S12000	31S12003 - 31S12003	31S12004 - 31S12004
Opzione 5: raccordo ambo i lati attacco dritto baionetta / Option 5: both ends straight plug in connection		
33TD0000 - 33TD0000	33TD0003 - 33TD0003	33TD0004 - 33TD0004
Si prega di scegliere tra le seguenti lunghezze standard in mm / Please choose among the following standard lengths in mm		
L200 - L400 - L630 - L800 - L1000 - L1500 - L2000 - L2500 - L3000 - L3500 - L4000 mm		

Normativa di riferimento
Reference regulations

Riferimento tubo / Hose code	
RD2 - RD3 - RD4	
Adatto per passaggio di oli minerali, oli idraulici tipo ASTM 3, benzine. Resistenza chimica all'olio per freni (tipo DOT 4) For mineral and hydraulic oil, type ASTM 3. fuel. Brake systems oil (type DOT 4).	

		RD2	RD3	RD4
Diametro esterno / Outside diameter	[mm]	5	6	8
Diametro interno / Inside diameter	[mm]	2.2	3	4
Pressione max. di lavoro / Max. working pressure	[bar]	630	500	500
Pressione minima di scoppio / Min. bursting pressure	[bar]	1890	1500	1500
Raggio minimo / Min. bending radius	[mm]	20	25	35
Temperature di esercizio / Working temperature	°C	-40...+100	-40...+100	-40...+100
Materiale anima / Core material	Poliestere termoplastico / Thermoplastic polyester			
Materiale treccia / Braid material	Fibra aramidica / Aramidic fibre			
Ricopertura est. / Cover material	Poliuretano antiabrasione / Antiabrasion polyurethane			
NS Codice / Our P/N		00RSD200	00RSD300	00RSD400



Tubo capillare per alta pressione e raccordi
Micro hose for high pressure and fittings

Opzioni di produzione e assemblaggio

Production and assembly options

- AI** Acciaio inossidabile:
 codice raccordo o tubo + "-AI"
 Stainless steel:
 fitting or hose assembly code + "-AI"
- V** Guarnizioni in FKM:
 codice raccordo o tubo + "-V"
 FKM sealing:
 fitting or hose assembly code + "-V"
- E** Guarnizioni in EPDM:
 codice raccordo o tubo + "-E"
 EPDM sealing:
 fitting or hose assembly code + "-E"

Cappuccio parapolvere in plastica per raccordi RD2 e RD4 F16X2, 16X1.5, S12,65X1,65 e baionetta

Anti-dust plastic cap suitable for RD2 and RD4 F16X2, 16X1.5, S12,65X1,65 and plug-in fittings

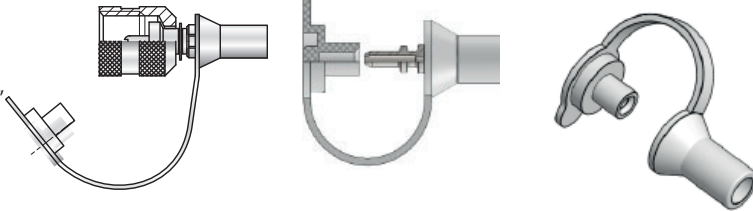

Codice/Ref.
32CP0000
32CP0004

Parapolvere protettivo per boccola in plastica per raccordi RD2 e RD4

Ferrules anti-dust cap for RD2 and RD4 fittings

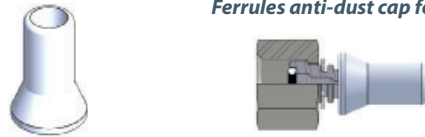

Codice/Ref.
32CS0000
32CS0004

I tubi capillari RD2 e RD4 raccordati sono sempre dotati di parapolvere 32CP000X e/o 32CS000X.
 In caso di acquisto di raccordi sciolti, i parapolvere 32CP000X e/o 32CS000X sono inclusi nel codice del raccordo.
RD2 and RD4 hose assemblies are always complete with the anti-dust caps 32CP000X and/or 32CS000X. In case of purchase of loose fittings, the anti-dust caps 32CP000X and/or 32CS000X are included in the fitting's part number.

Raccordo connessione avvitabile per miniprese

Test coupling threaded female fitting

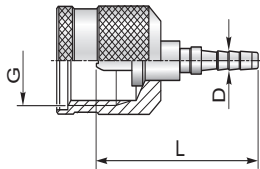

Tubo / Hose	G	L	D	Codice/Ref.
RD2	M16x2*	32.5	2.0	31TTN000
	M16x1.5*	32.5	2.0	31TTS000
	M12.65x1.5	32.5	2.0	31S12000
RD3	M16x2	37.2	3.0	31TTN003
	M16x1.5	37.2	3.0	31TTS003
	M12.65x1.5	37.2	3.0	31S12003
RD4	M16x2*	36.5	4.0	31TTN004
	M16x1.5*	36.5	4.0	31TTS004
	M12.65x1.5	36.5	4.0	31S12004

* Disponibili in acciaio inossidabile / Available in Stainless steel

45°

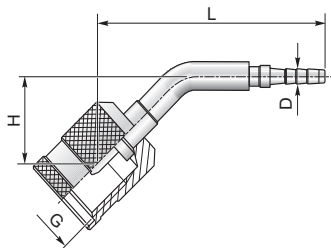

Tubo / Hose	G	L	H	D	Codice/Ref.
RD2	M16x2	48	18	2.0	31TTN040
	M16x1.5	48	18	2.0	31TTS040
	M12.65x1.5	48	18	2.0	31S12040
RD3	M16x2	48	18.5	3.0	31TTN043
	M16x1.5	48	18.5	3.0	31TTS043
	M12.65x1.5	48	18.5	2.0	31S12043
RD4	M16x2	53	18.5	4.0	31TTN044
	M16x1.5	53	18.5	4.0	31TTS044
	M12.65x1.5	53	18.5	4.0	31S12044

90°

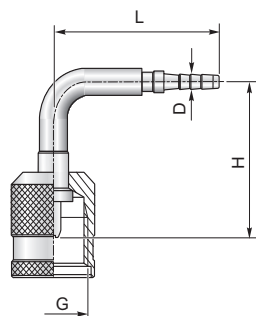

Tubo / Hose	G	L	H	D	Codice/Ref.
RD2	M16x2*	34.5	31.0	2.0	31TTN090
	M16x1.5	34.5	31.0	2.0	31TTS090
	M12.65x1.5	34.5	31	2.0	31S12090
RD3	M16x2	34.5	31.0	3.0	31TTN093
	M16x1.5	34.5	31.0	3.0	31TTS093
	M12.65x1.5	34.5	31	3.0	31S12093
RD4	M16x2	34.5	31.0	4.0	31TTN094
	M16x1.5	34.5	31.0	4.0	31TTS094
	M12.65x1.5	34.5	31	4.0	31S12094

* Disponibili in acciaio inossidabile / Available in Stainless steel



Raccordo connessione avvitabile per miniprese con dado esagonale

Test coupling threaded female fitting with hexagonal nut

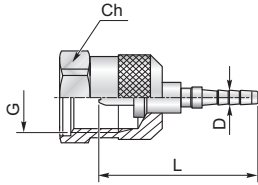

Tubo / Hose	G	L	Ch	D	Codice/Ref.
RD2	M16x2*	32.5	19	2.0	31TTN600
	M16x1.5	32.5	19	2.0	31TTS600
RD3	M16x2	37.2	19	3.0	31TTN603
	M16x1.5	37.2	19	3.0	31TTS603
RD4	M16x2	36.5	19	4.0	31TTN604
	M16x1.5	36.5	19	4.0	31TTS604

* Disponibili in acciaio inossidabile/ Available in Stainless steel

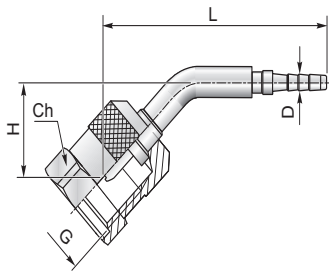

45°						
Tubo / Hose	G	L	H	Ch	D	Codice/Ref.
RD2	M16x2	48	18	19	2.0	31TTN640
	M16x1.5	48	18	19	2.0	31TTS640
RD3	M16x2	48	18.5	19	3.0	31TTN643
	M16x1.5	48	18.5	19	3.0	31TTS643
RD4	M16x2	53	18.5	19	4.0	31TTN644
	M16x1.5	53	18.5	19	4.0	31TTS644

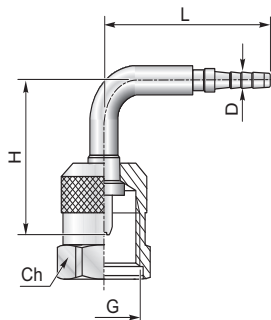

90°						
Tubo / Hose	G	L	H	Ch	D	Codice/Ref.
RD2	M16x2	34.5	31	19	2.0	31TTN690
	M16x1.5	34.5	31	19	2.0	31TTS690
RD3	M16x2	34.5	31	19	3.0	31TTN693
	M16x1.5	34.5	31	19	3.0	31TTS693
RD4	M16x2	34.5	31	19	4.0	31TTN694
	M16x1.5	34.5	31	19	4.0	31TTS694



Tubo capillare per alta pressione e raccordi
Micro hose for high pressure and fittings



Raccordo connessione avvitabile per manometro

Gauges threaded fitting

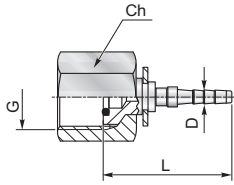

Tubo / Hose	G	L	Ch	D	Codice/Ref.
RD2	G 1/4*	26	19	2.0	36140000
	G 3/8	24	22	2.0	36380000
	G 1/2*	33.5	27	2.0	36120000
	M12X1.5	26	14	2.0	36M2000
	M14X1.5	26	19	2.0	36M4000
	M20X1.5	33.5	24	2.0	36M20R00
RD3	G 1/4	30	19	3.0	36140R03
	G 1/2	37.5	27	3.0	36120R03
	M20X1.5	37.5	24	3.0	36M20R03
RD4	G 1/4	36.5	19	4.0	36140R04
	G 1/2	37.3	27	4.0	36120R04
	M20X1.5	37.3	24	4.0	36M20R04

*** Disponibili in acciaio inossidabile/ Available in Stainless steel**

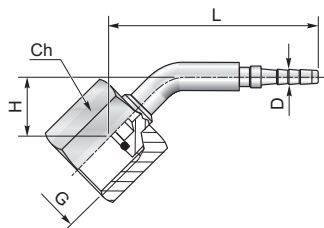

45°						
Tubo / Hose	G	H	L	Ch	D	Codice/Ref.
RD2	G 1/4	14.0	47.0	19	2.0	36140040
	G 1/2	21.0	54.5	27	2.0	36120040
	M20X1.5	21.0	54.5	24	2.0	36M20R40
RD3	G 1/4	14.0	47.0	19	3.0	36140R43
	G 1/2	21.0	54.5	27	3.0	36120R43
	M20X1.5	21.0	54.5	24	3.0	36M20R43
RD4	G 1/4	14.0	52.0	19	4.0	36140R44
	G 1/2	21.0	59.5	27	4.0	36120R44
	M20X1.5	21.0	59.5	24	4.0	36M20R44

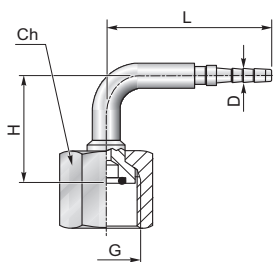

90°						
Tubo / Hose	G	H	L	Ch	D	Codice/Ref.
RD2	G 1/4	25.0	38.0	19	2.0	36140090
	G 1/2	37.5	41.5	27	2.0	36120090
	M20X1.5	37.5	41.5	24	2.0	36M20R90
RD3	G 1/4	25.0	38.0	19	3.0	36140R93
	G 1/2	37.5	41.5	27	3.0	36120R93
	M20X1.5	37.5	41.5	24	3.0	36M20R93
RD4	G 1/4	25.0	43.0	19	4.0	36140R94
	G 1/2	37.5	46.5	27	4.0	36120R94
	M20X1.5	37.5	46.5	24	4.0	36M20R94



Raccordo connessione avvitabile per manometro con rondella di rame

Gauges threaded fitting with copper ring

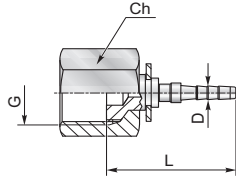

Tubo / Hose	G	L	Ch	D	Codice/Ref.
RD2	G 1/4	26	19	2.0	3614CR00
	G 1/2	33.5	27	2.0	3612CR00
	M20X1.5	33.5	24	2.0	36M2CR00
RD3	G 1/4	30	19	3.0	3614CR03
	G 1/2	37.5	27	3.0	3612CR03
	M20X1.5	37.5	24	3.0	36M2CR03
RD4	G 1/4	36.5	19	4.0	3614CR04
	G 1/2	37.5	27	4.0	3612CR04
	M20X1.5	36.5	24	4.0	36M2CR04

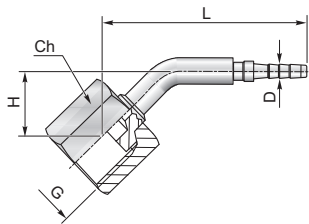

45°						
Tubo / Hose	G	H	L	Ch	D	Codice/Ref.
RD2	G 1/4	14	47	19	2.0	3614CR40
	G 1/2	21	54.5	27	2.0	3612CR40
	M20X1.5	21	54.5	24	2.0	36M2CR40
RD3	G 1/4	14	47	19	3.0	3614CR43
	G 1/2	21	54.5	27	3.0	3612CR43
	M20X1.5	21	54.5	24	3.0	36M2CR43
RD4	G 1/4	14	52	19	4.0	3614CR44
	G 1/2	21	59.5	27	4.0	3612CR44
	M20X1.5	21	59.5	24	4.0	36M2CR44

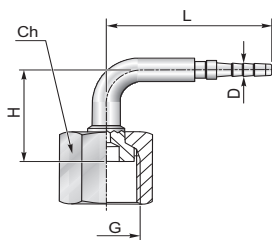

90°						
Tubo / Hose	G	H	L	Ch	D	Codice/Ref.
RD2	G 1/4	25	38	19	2.0	3614CR90
	G 1/2	37.5	41.5	27	2.0	3612CR90
	M20X1.5	37.5	41.5	24	2.0	36M2CR90
RD3	G 1/4	25	38	19	3.0	3614CR93
	G 1/2	37.5	41.5	27	3.0	3612CR93
	M20X1.5	37.5	41.5	24	3.0	36M2CR93
RD4	G 1/4	25	43	19	4.0	3614CR94
	G 1/2	37.5	46.5	27	4.0	3612CR94
	M20X1.5	37.5	46.5	24	4.0	36M2CR94



Tubo capillare per alta pressione e raccordi
Micro hose for high pressure and fittings



Raccordo connessione avvitabile per manometro

Gauges threaded fitting

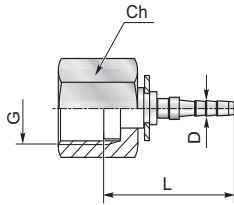

Tubo / Hose	G	L	Ch	D	Codice/Ref.
RD2	G 1/8	22.6	14	2.0	4918DF00
	G 1/4	23.5	17	2.0	4914DF00
RD3	G 1/8	26.6	14	3.0	4918DF03
	G 1/4	27.5	17	3.0	4914DF03
RD4	G 1/8	26.6	14	4.0	4918DF04
	G 1/4	27.5	17	4.0	4914DF04

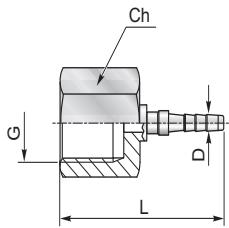

Tubo / Hose	G	L	Ch	D	Codice/Ref.
RD2	1/4-18 NPTF*	32	19	2.0	37140000
RD2	1/8"-27 NPTF	30	17	2.0	37180000
RD3	1/4-18 NPTF	36	19	3.0	37140003
RD4	1/4-18 NPTF	36	19	4.0	37140004

*** Disponibili in acciaio inossidabile / Available in Stainless steel**

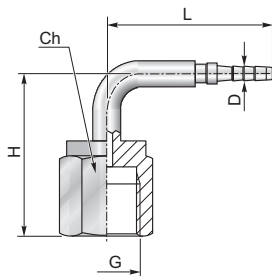

90°						
Tubo / Hose	G	H	L	Ch	D	Codice/Ref.
RD2	1/4-18 NPTF	34.2	43.7	19	2.0	37140090
RD3	1/4-18 NPTF	34.2	43.7	19	3.0	37140093
RD4	1/4-18 NPTF	34.2	43.7	19	4.0	37140094



Raccordo femmina girevole connessione cono 60° tipo DKR

Swivel female fitting 60° cone connection type DKR

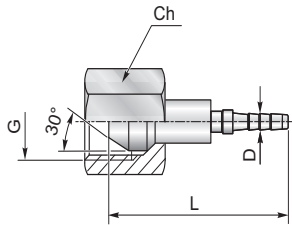

Tubo / Hose	G	L	Ch	D	Codice/Ref.
RD2	G 1/8*	24	14	2.0	38180000
	G 1/4*	26	17	2.0	38140000
	G 3/8	29	22	2.0	38380000
	M14x1.5	26	17	2.0	38141500
	M12x1.5	24	14	2.0	38121500
RD3	G 1/8*	28	14	3.0	38180003
	G 1/4	30	17	3.0	38140003
	M10x1	28	12	3.0	38100003
RD4	G 1/8*	28	14	4.0	38180004
	G 1/4*	30	17	4.0	38140004

* Disponibili in acciaio inossidabile/ Available in Stainless steel

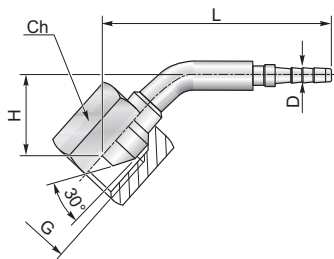

45°

Tubo / Hose	G	H	L	Ch	D	Codice/Ref.
RD2	G 1/8	15	44.5	14	2.0	38180040
	G 1/4	16	47.5	17	2.0	38140040
RD3	G 1/8	15	44.5	14	3.0	38180043
	G 1/4	16	47.5	17	3.0	38140043
RD4	G 1/8	15	49.5	14	4.0	38180044
	G 1/4	16	52.5	17	4.0	38140044

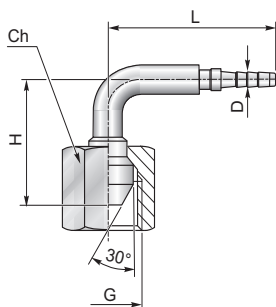

90°

Tubo / Hose	G	H	L	Ch	D	Codice/Ref.
RD2	G 1/8	20	34	14	2.0	38180090
	G 1/4	27.5	36.5	17	2.0	38140090
RD3	G 1/8	20	34	14	3.0	38180093
	G 1/4	27.5	36.5	17	3.0	38140093
RD4	G 1/8	20	38	14	4.0	38180094
	G 1/4*	27.5	41.5	17	4.0	38140094

* Disponibili in acciaio inossidabile/ Available in Stainless steel



Tubo capillare per alta pressione e raccordi
Micro hose for high pressure and fittings



Raccordo femmina girevole connessione cono 24° tipo DKL

Swivel female fitting 24° cone connection type DKL

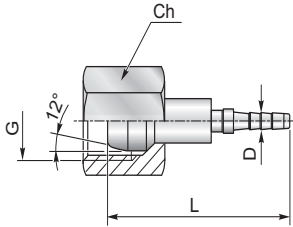

Tubo / Hose	Ø	G	L	Ch	D	Codice/Ref.
RD2	6	M12x1.5	31.5	14	2.0	45R00000
	8	M14x1.5	37	17	2.0	45R20000
	10	M16x1.5	36.5	19	2.0	45R50000
RD3	6	M12x1.5	35	14	3.0	45R00003
	8	M14x1.5	37	17	3.0	45R20003
	10	M16x1.5	37	19	3.0	45R50003
RD4	6	M12x1.5	36	14	4.0	45R00004
	8	M14x1.5	36	17	4.0	45R20004
	10	M16x1.5	41.5	19	4.0	45R50004

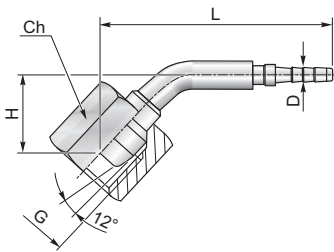

45°							
Tubo / Hose	Ø	G	H	L	Ch	D	Codice/Ref.
RD2	6	M12x1.5	14.3	45	14	2.0	45R00040
	8	M14x1.5	16	52.3	17	2.0	45R20040
	10	M16x1.5	19	57.3	19	2.0	45R50040
RD3	6	M12x1.5	14.3	49.3	14	3.0	45R00043
	8	M14x1.5	16	56.2	17	3.0	45R20043
	10	M16x1.5	19	61.4	19	3.0	45R50043
RD4	6	M12x1.5	14.3	49.3	14	4.0	45R00044
	8	M14x1.5	16	56.2	17	4.0	45R20044
	10	M16x1.5	19	61.4	19	4.0	45R50044

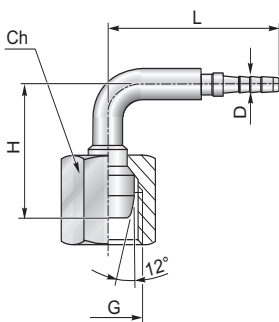

90°							
Tubo / Hose	Ø	G	H	L	Ch	D	Codice/Ref.
RD2	6	M12x1.5	22.5	40	14	2.0	45R00090
	8	M14x1.5	36.5	39.5	17	2.0	45R20090
	10	M16x1.5	35.8	42.7	19	2.0	45R50090
RD3	6	M12x1.5	22.5	45	14	3.0	45R00093
	8	M14x1.5	36.5	43.9	17	3.0	45R20093
	10	M16x1.5	35.8	46.7	19	3.0	45R50093
RD4	6	M12x1.5	22.5	45	14	4.0	45R00094
	8	M14x1.5	36.5	43.9	17	4.0	45R20094
	10	M16x1.5	35.8	46.7	19	4.0	45R50094



Raccordo femmina girevole connessione cono 24° tipo DKOL

Swivel female fitting 24° cone connection type DKOL

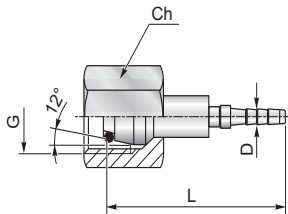

Tubo / Hose	Ø	G	L	Ch	D	Codice/Ref.
RD2	6*	M12x1.5	31.6	14	2.0	35R00000
	8*	M14x1.5	31.6	17	2.0	35R20000
	10*	M16x1.5	31.5	19	2.0	35R50000
	12	M18x1.5	36	22	2.0	35R60000
RD3	6	M12x1.5	37	14	3.0	35R00003
	8	M14x1.5	35	17	3.0	35R20003
	10	M16x1.5	36.5	19	3.0	35R50003
RD4	6*	M12x1.5	37	14	4.0	35R00004
	8	M14x1.5	36	17	4.0	35R20004
	10	M16x1.5	38.5	19	4.0	35R50004
	12	M18x1.5	40	22	4.0	35R60004

* Disponibili in acciaio inossidabile/ Available in Stainless steel

45°

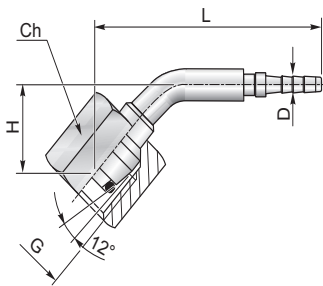

Tubo / Hose	Ø	G	H	L	Ch	D	Codice/Ref.
RD2	6	M12x1.5	15	47.5	14	2.0	35R00040
	8	M14x1.5	16	52	17	2.0	35R20040
	10	M16x1.5	19	56	19	2.0	35R50040
RD3	6	M12x1.5	15	51.5	14	3.0	35R00043
	8	M14x1.5	19	56	17	3.0	35R20043
	10	M16x1.5	19	61	19	3.0	35R50043
RD4	6*	M12x1.5	15	51.5	14	4.0	35R00044
	8	M14x1.5	19	56	17	4.0	35R20044
	10	M16x1.5	19	61	19	4.0	35R50044
	12	M18x1.5	20	62	22	4.0	35R60044

* Disponibili in acciaio inossidabile/ Available in Stainless steel

90°

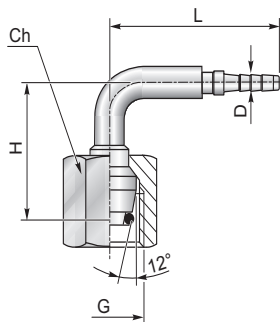

Tubo / Hose	Ø	G	H	L	Ch	D	Codice/Ref.
RD2	6	M12x1.5	25	35.5	14	2.0	35R00090
	8	M14x1.5	36	40.5	17	2.0	35R20090
	10	M16x1.5	36	41.5	19	2.0	35R50090
RD3	6	M12x1.5	25	39.5	14	3.0	35R00093
	8	M14x1.5	36	40.5	17	3.0	35R20093
	10	M16x1.5	36	46.5	19	3.0	35R50093
RD4	6*	M12x1.5	25	39.5	14	4.0	35R00094
	8	M14x1.5	36	45.5	17	4.0	35R20094
	10	M16x1.5	36	46.5	19	4.0	35R50094
	12	M18x1.5	38	48.5	22	4.0	35R60094

* Disponibili in acciaio inossidabile/ Available in Stainless steel



Tubo capillare per alta pressione e raccordi
Micro hose for high pressure and fittings



Raccordo femmina girevole connessione cono 24° tipo DKOLL

Swivel female fitting 24° cone connection type DKOLL

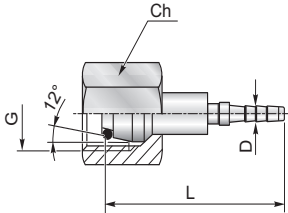

Tubo / Hose	Ø	G	L	Ch	D	Codice/Ref.
RD2	4	M8x1	28	10	2.0	46R00000
	6	M10x1	30	12	2.0	46R10000
RD3	4	M8x1	32	10	3.0	46R00003
	6	M10x1	35	12	3.0	46R10003
RD4	4	M8x1	32	10	4.0	46R00004
	6	M10x1	34	12	4.0	46R10004

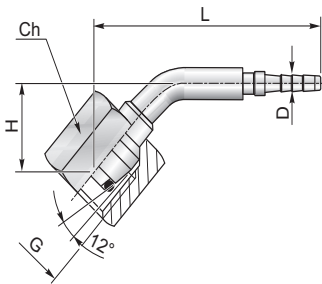

45°

Tubo / Hose	Ø	G	H	L	Ch	D	Codice/Ref.
RD2	4	M8x1	16.5	49	10	2.0	46R00040
	6	M10x1	16	52.5	12	2.0	46R10040
RD3	6	M10x1	16	56.5	12	3.0	46R10043
RD4	6	M10x1	16	56.5	12	4.0	46R10044

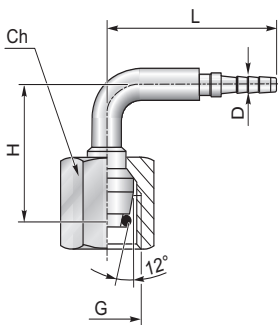

90°

Tubo / Hose	Ø	G	H	L	Ch	D	Codice/Ref.
RD2	4	M8x1	28	38	10	2.0	46R00090
	6	M10x1	26	42	12	2.0	46R10090
RD3	6	M10x1	26	46	12	3.0	46R10093
RD4	6	M10x1	26	46	12	4.0	46R10094



Raccordo femmina girevole connessione cono 24° tipo DKOS

Swivel female fitting 24° cone connection type DKOS

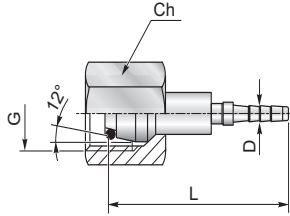

Tubo / Hose	Ø	G	L	Ch	D	Codice/Ref.
RD2	6*	M14x1.5	31.6	17	2.0	35R10000
	8*	M16x1.5	31.6	19	2.0	35R30000
	10*	M18x1.5	31.5	22	2.0	35R40000
	12*	M20x1.5	36	24	2.0	35R70000
RD3	6	M14x1.5	37	17	3.0	35R10003
	8	M16x1.5	35	19	3.0	35R30003
	10	M18x1.5	37	22	3.0	35R40003
RD4	6*	M14x1.5	35.5	17	4.0	35R10004
	8*	M16x1.5	38.5	19	4.0	35R30004
	10	M18x1.5	40	22	4.0	35R40004
	12	M20x1.5	40	24	4.0	35R70004

* Disponibili in acciaio inossidabile/ Available in Stainless steel

45°

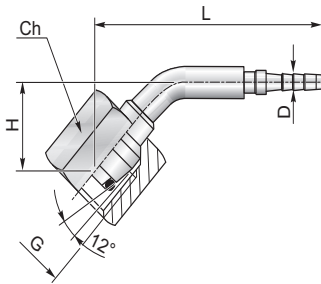

Tubo / Hose	Ø	G	H	L	Ch	D	Codice/Ref.
RD2	6	M14x1.5	15	47.5	17	2.0	35R10040
	8	M16x1.5	16	52	19	2.0	35R30040
	10	M18x1.5	19	56	22	2.0	35R40040
RD3	6	M14x1.5	15	51.5	17	3.0	35R10043
	8	M16x1.5	19	56	19	3.0	35R30043
	10	M18x1.5	19	61	22	3.0	35R40043
RD4	6*	M14x1.5	15	51.5	17	4.0	35R10044
	8	M16x1.5	19	56	19	4.0	35R30044
	10	M18x1.5	19	61	22	4.0	35R40044
	12	M20x1.5	20	62	24	4.0	35R70044

* Disponibili in acciaio inossidabile/ Available in Stainless steel

90°

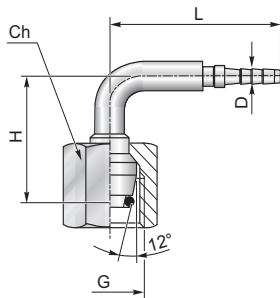

Tubo / Hose	Ø	G	H	L	Ch	D	Codice/Ref.
RD2	6	M14x1.5	25	35.5	17	2.0	35R10090
	8	M16x1.5	36	40.5	19	2.0	35R30090
	10	M18x1.5	36	41.5	22	2.0	35R40090
RD3	6	M14x1.5	25	39.5	17	3.0	35R10093
	8	M16x1.5	36	40.5	19	3.0	35R30093
	10	M18x1.5	36	46.5	22	3.0	35R40093
RD4	6*	M14x1.5	25	39.5	17	4.0	35R10094
	8	M16x1.5	36	45.5	19	4.0	35R30094
	10	M18x1.5	36	46.5	22	4.0	35R40094
	12	M20x1.5	38	48.5	24	4.0	35R70094

* Disponibili in acciaio inossidabile/ Available in Stainless steel



Raccordo femmina girevole connessione JIC 74° tipo DKJ

Swivel female fitting JIC 74° connection type DKJ

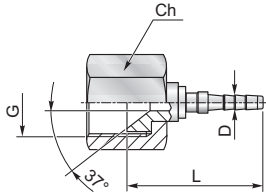

Tubo / Hose	G	L	Ch	D	Codice/Ref.
RD2	7/16-20 UNF*	25	14	2.0	39160000
	1/2-20 UNF	26	17	2.0	39120000
	3/8-24 UNF*	24.5	12	2.0	3938J000
	9/16-18 UNF	28.5	17	2.0	3991J000
RD3	7/16-20 UNF	29	14	3.0	39160003
	1/2-20 UNF	30	17	3.0	39120003
	3/8-24 UNF	27	12	3.0	3938J003
RD4	7/16-20 UNF*	28	14	4.0	39160004
	1/2-20 UNF	30	17	4.0	39120004
	3/8-24 UNF	28.5	12	4.0	3938J004

* Disponibili in acciaio inossidabile/ Available in Stainless steel

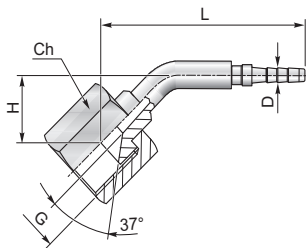

45°						
Tubo / Hose	G	H	L	Ch	D	Codice/Ref.
RD2	7/16-20 UNF	13	46.5	14	2.0	39160040
	1/2-20 UNF	13	46.5	17	2.0	39120040
	3/8-24 UNF	13	46.5	12	2.0	3938J040
	9/16-18 UNF	15.5	54.5	17	2.0	3991J040
RD3	7/16-20 UNF	13	46.5	14	3.0	39160043
	1/2-20 UNF	13	51.5	17	3.0	39120043
	3/8-24 UNF	13	51.5	12	3.0	3938J043
RD4	7/16-20 UNF	13	51.5	14	4.0	39160044
	1/2-20 UNF	13	51.5	17	4.0	39120044
	3/8-24 UNF	13	51.5	12	4.0	3938J044

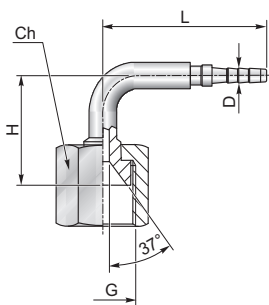

90°						
Tubo / Hose	G	H	L	Ch	D	Codice/Ref.
RD2	7/16-20 UNF*	25	37	14	2.0	39160090
	1/2-20 UNF	25	36.5	17	2.0	39120090
	3/8-24 UNF	24	40	12	2.0	3938J090
RD3	7/16-20 UNF	24.5	45	14	3.0	39160093
	1/2-20 UNF	25	41.5	17	3.0	39120093
	3/8-24 UNF	24	40	12	3.0	3938J093
RD4	7/16-20 UNF*	24.5	45	14	4.0	39160094
	1/2-20 UNF	25	41.5	17	4.0	39120094
	3/8-24 UNF	24	40	12	4.0	3938J094

* Disponibili in acciaio inossidabile/ Available in Stainless steel



Raccordo femmina tipo ORFS

ORFS female fitting, UNF thread

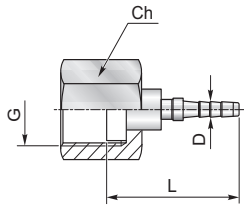

Tubo / Hose	G	L	Ch	D	Codice/Ref.
RD2	9/16-18 UNF	28.5	19	2.0	5991F000
	11/16-16 UNF	33	22	2.0	5911F000
RD3	9/16-18 UNF	32.5	19	3.0	5991F003
	11/16-16 UNF	35	22	2.0	5911F003
RD4	9/16-18 UNF	32.5	19	4.0	5991F004

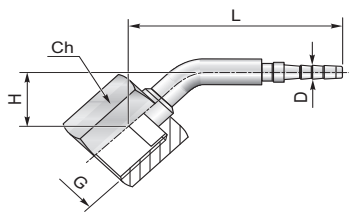

45°						
Tubo / Hose	G	H	L	Ch	D	Codice/Ref.
RD2	9/16-18 UNF	15	46	19	2.0	5991F040
RD3	9/16-18 UNF	15	51	19	3.0	5991F043
RD4	9/16-18 UNF	15	51	19	4.0	5991F044

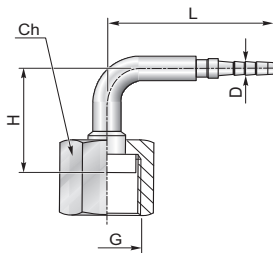

90°						
Tubo / Hose	G	H	L	Ch	D	Codice/Ref.
RD2	9/16-18 UNF	25	37.5	19	2.0	5991F090
RD3	9/16-18 UNF	25	42.5	19	3.0	5991F093
RD4	9/16-18 UNF	25	42.5	19	4.0	5991F094



Tubo capillare per alta pressione e raccordi
Micro hose for high pressure and fittings



Raccordi a codolo liscio

Standpipe fitting

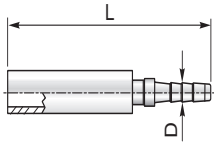

Tubo / Hose	Ø	L	D	Codice/Ref.
RD2	4	36	2.0	34R70000
	6*	36	2.0	34R00000
	8*	36	2.0	34R30000
	10	36	2.0	34R50000
RD3	4	41	3.0	34R70003
	6	36	3.0	34R00003
	8	37.5	3.0	34R30003
RD4	4	41	4.0	34R70004
	6	41	4.0	34R00004
	8	41	4.0	34R30004

* Disponibili in acciaio
inossidabile/ Available in
Stainless steel

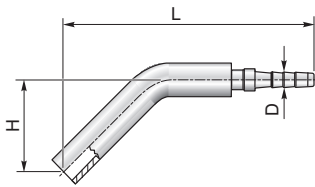

45°					
Tubo / Hose	Ø	H	L	D	Codice/Ref.
RD2	4	14.5	43	2.0	34R70040
	6	16.5	44	2.0	34R00040
	8	20	52	2.0	34R30040
RD3	4	14.5	43	3.0	34R70043
	6	16.5	44	3.0	34R00043
	8	20	52	3.0	34R30043
RD4	4	14.5	48	4.0	34R70044
	6	16.5	49	4.0	34R00044
	8	20	57	4.0	34R30044

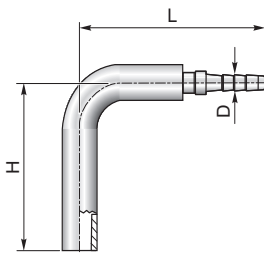

90°					
Tubo / Hose	Ø	H	L	D	Codice/Ref.
RD2	4	25.5	33	2.0	34R70090
	6	28	32	2.0	34R00090
	8	37	41	2.0	34R30090
RD3	4	25.5	33	3.0	34R70093
	6	28	32	3.0	34R00093
	8	37	41	3.0	34R30093
RD4	4	25.5	38	4.0	34R70094
	6	28	37	4.0	34R00094
	8	37	46	4.0	34R30094



Raccordo ad occhio e dado forato

Banjo fitting and banjo screw

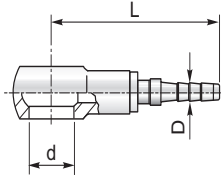

Tubo / Hose	d	Dado Forato / Banjo Screw	L	D	Codice/Ref.
RD2	6	M6X1	36.5	2.0	42R40000
	8	M8X1	29.5	2.0	42R10000
	10	M10X1 - G1/8	31.5	2.0	42R00000
RD3	8*	M8X1	29.5	3.0	42R10003
	10	M10X1 - G1/8	31.5	3.0	42R00003
RD4	8*	M8X1	34.5	4.0	42R10004
	10	M10X1 - G1/8	36.5	4.0	42R00004
	14	M14X1,5 - G1/4	40.5	4.0	42R20004

* Disponibili in acciaio inossidabile/ Available in Stainless steel

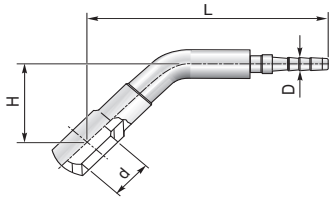

45°					
Tubo / Hose	d	H	L	D	Codice/Ref.
RD2	8	17.5	45.5	2.0	42R10040
RD3	8	17.5	49.5	3.0	42R10043
RD4	8	17.5	49.5	4.0	42R10044

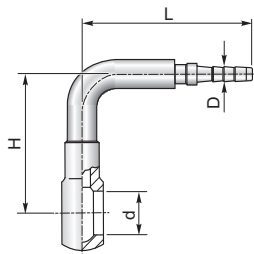

90°					
Tubo / Hose	d	H	L	D	Codice/Ref.
RD2	8	28.5	33	2.0	42R10090
RD3	8	28.5	38	3.0	42R10093
RD4	8	28.5	38	4.0	42R10094

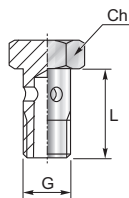

G	L	Ch	Codice/Ref.
M8x1*	17	12	42R0HS00
M10x1	19	14	42R1HS00
G1/8	18	14	4218HS00

* Disponibili in acciaio inossidabile/ Available in Stainless steel

Vite smorzatore di pressione Reg. M8x1.25

Pressure dumper screw M8x1.25

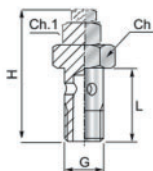

G	H	L	Ch	Ch 1	Codice/Ref.
G1/4	50	29	19	13	4214HS30
G1/8	53	31	22	13	4238HS35



Raccordi maschio fisso

Male fittings

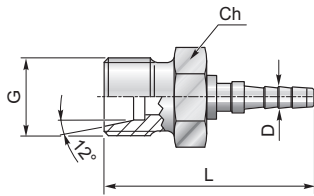

Tubo / Hose	G	L	Ch	D	Codice/Ref.
RD2	M12x1.5	32	14	2.0	44MFLR00
	M14x1.5	32	17	2.0	44MFLR10
	M16x1.5	33	19	2.0	44MFLR30
RD3	M12x1.5	36	14	3.0	44MFLR03
	M14x1.5	36	17	3.0	44MFLR13
	M16x1.5	37	19	3.0	44MFLR33
RD4	M12x1.5	37	14	4.0	44MFLR04
	M14x1.5	37	17	4.0	44MFLR14
	M16x1.5	38	19	4.0	44MFLR34

Serie L / L Series

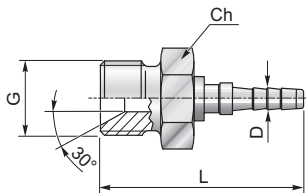

Tubo / Hose	G	L	Ch	D	Codice/Ref.
RD2	G 1/8	31	14	2.0	44MFG180
	G 1/4	36	19	2.0	44MFG140
RD3	G 1/8	36.5	14	3.0	44MFG183
	G 1/4	38.5	19	3.0	44MFG143
RD4	G 1/8	39	14	4.0	44MFG184
	G 1/4	38.5	19	4.0	44MFG144
	G 3/8	42.5	22	4.0	44MFG384

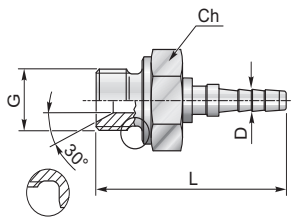

Tubo / Hose	G	L	Ch	D	Codice/Ref.
RD2	G 1/8	33.5	14	2.0	44MFM180
	G 1/4	37.5	19	2.0	44MFM140
RD3	G 1/8	35	14	3.0	44MFM183
	G 1/4	41	19	3.0	44MFM143
RD4	G 1/8	37.5	14	4.0	44MFM184
	G 1/4	41	19	4.0	44MFM144

Tenuta con rondella di rame (non inclusa) / Sealing with copper washer (not included)

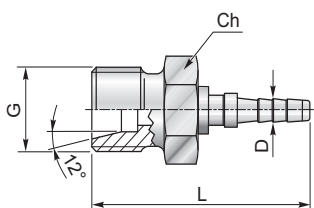

Tubo / Hose	G	L	Ch	D	Codice/Ref.
RD2	M14x1.5	34	17	2.0	44MFSR00
	M16x1.5*	34	19	2.0	44MFSR10
	M18x1.5	35.5	22	2.0	44MFSR20
RD3	M14x1.5	38	17	3.0	44MFSR03
	M16x1.5	38	19	3.0	44MFSR13
	M18x1.5	38.5	22	3.0	44MFSR23
RD4	M14x1.5	39	17	4.0	44MFSR04
	M16x1.5	39	19	4.0	44MFSR14
	M18x1.5	40.5	22	4.0	44MFSR24
	M20x1.5	41	24	4.0	44MFSR34

Serie S / S Series

* Disponibili in acciaio inossidabile / Available in Stainless steel



Raccordi maschio fisso

Male fittings

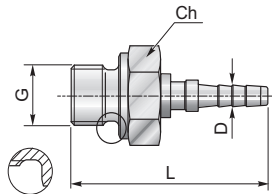

Tubo / Hose	G	L	Ch	D	Codice/Ref.
RD2	M8x1	32	12	2.0	44MFDR00
	M10x1	32	14	2.0	44MFDR10
	M12x1.5	33	17	2.0	44MFDR30
	M5x1	32	12	2.0	44MFDRM5
RD3	M8x1	36	12	3.0	44MFDR03
	M10x1	36	14	3.0	44MFDR13
	M12x1.5	37	17	3.0	44MFDR33
RD4	M8x1	37	12	4.0	44MFDR04
	M10x1	37	14	4.0	44MFDR14
	M12x1.5	38	17	4.0	44MFDR34

Sede piana / Flat sealing

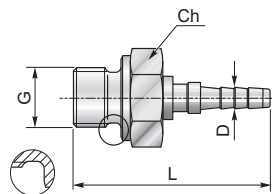

Tubo / Hose	G	L	Ch	D	Codice/Ref.
RD2	G 1/8	30.5	14	2.0	44MFD180
	G 1/4	35.5	19	2.0	44MFD140
RD3	G 1/8	35.5	14	3.0	44MFD183
	G 1/4	41	19	3.0	44MFD143
RD4	G 1/8	35.5	14	4.0	44MFD184
	G 1/4	41	19	4.0	44MFD144

Sede piana / Flat sealing

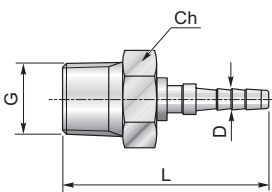

Tubo / Hose	G	L	Ch	D	Codice/Ref.
RD2	R 1/8	30.5	12	2.0	44MFC180
	R 1/4	33.5	14	2.0	44MFC140
RD3	R 1/8	33.5	12	3.0	44MFC183
	R 1/4	38.5	14	3.0	44MFC143
RD4	R 1/8	34.5	12	4.0	44MFC184
	R 1/4	37.5	14	4.0	44MFC144

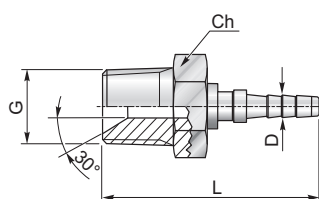

Tubo / Hose	G	L	Ch	D	Codice/Ref.
RD2	1/8-27 NPTF	28.5	12	2.0	44MF8000
	1/4-18 NPTF*	36	17	2.0	44MF4000
RD3	1/8-27 NPTF	33.5	12	3.0	44MF8003
	1/4-18 NPTF	38.5	17	3.0	44MF4003
RD4	1/8-27 NPTF	35	12	4.0	44MF8004
	1/4-18 NPTF	41	17	4.0	44MF4004

* Disponibili in acciaio inossidabile / Available in Stainless steel



Tubo capillare per alta pressione e raccordi
Micro hose for high pressure and fittings



Raccordo maschio tipo ORFS

ORFS male fitting, UNF thread

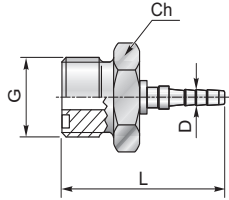

Tubo / Hose	G	L	Ch	D	Codice/Ref.
RD2	9/16-18 UNF	31	17	2.0	5991M000
RD3	9/16-18 UNF	35	17	3.0	5991M003
RD4	9/16-18 UNF	35	17	4.0	5991M004

Raccordo maschio JIC 74°

JIC 74° Male fitting

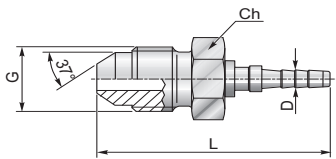

Tubo / Hose	G	L	Ch	D	Codice/Ref.
RD2	3/8-28 UNF	34	12	2.0	44AJ3800
	7/16-20 UNF*	38	14	2.0	44AJ7100
	1/2-20 UNF	39	17	2.0	44AJ1200
RD3	3/8-24 UNF	38	12	3.0	44AJ3803
	7/16-20 UNF	42	14	3.0	44AJ7103
	1/2-20 UNF	43	17	3.0	44AJ1203
RD4	3/8-24 UNF	38	12	4.0	44AJ3804
	7/16-20 UNF	42	14	4.0	44AJ7104
	1/2-20 UNF	43	17	4.0	44AJ1204

*** Disponibili in acciaio inossidabile/ Available in Stainless steel**

Raccordo maschio per porta manometro

Gauge male fitting

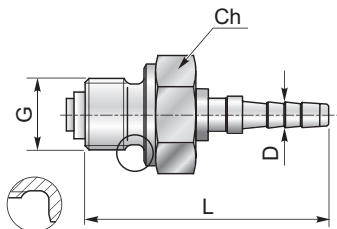

Tubo / Hose	G	L	Ch	D	Codice/Ref.
RD4	ISO 228 G 1/4"	44	17	4.0	44GC1404



Innesto per minipresa a baionetta

Plug-in connection

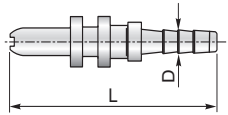

Tubo / Hose	L	D	Codice/Ref.
RD2*	27	2.0	33TD0000
RD3	31	3.0	33TD0003
RD4	31	4.0	33TD0004

* Disponibili in acciaio inossidabile/ Available in Stainless steel

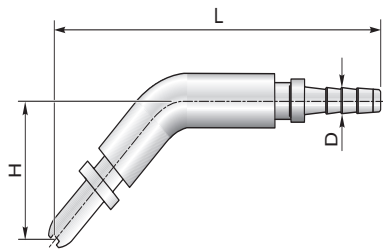

45°

Tubo / Hose	H	L	D	Codice/Ref.
RD2	22	56	2.0	33TD0040
RD3	24	59	3.0	33TD0043
RD4	24	59	4.0	33TD0044

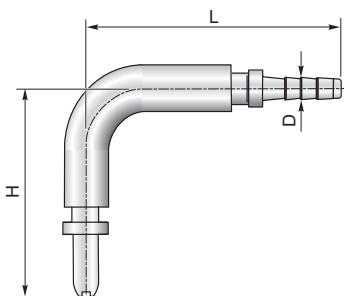

90°

Tubo / Hose	H	L	D	Codice/Ref.
RD2	28	32	2.0	33TD0090
RD3	28	36	3.0	33TD0093
RD4	28	36	4.0	33TD0094

Ghiera a pressare

Ferrule

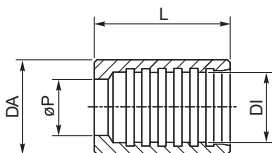

DA	DI	L	ØP	Ø Tubo est. / ext. hose Ø	Ø Press	PN [bar]	Codice/Ref.
8*#	5.65	15	4.5	5.5	7.1	600	30BT0000
8*#	5.15	15	4.5	5 (RD2)	7.1	600	30BT2000
9*	6.6	17	6.2	6 (RD3)	7.6	600	30BT3000
12*°	9.2	17	6.5	8.6	10.2	600	30BT4000
12*°	8.6	17	6.5	8 (RD4)	10.2	600	30BT4001

* Disponibili in acciaio inossidabile/ Available in Stainless steel

Ø Press = Diametro di pressatura / Crimping diameters

Compatibile con serie di raccordi Mini Press RD2 / suitable with RD2 Mini Press fittings range

° Compatibile con serie di raccordi Mini Press RD4 / suitable with RD4 Mini Press fittings range

- La boccola non è inclusa nel codice del raccordo, è da ordinare separatamente.
- The ferrule is not included in the fitting code, it is to be ordered separately.



Manometro digitale Service Junior

Service Junior digital gauge



G1/4" ISO 228 flat gasket sealing

- Misurazione e visualizzazione digitale della pressione / *Digital pressure measurement and display*
- Precisione $\pm 0,5\%$ FS / *Accuracy $\pm 0,5\%$ FS*
- Visualizzazione con grafico a barre con funzione di memorizzazione dei livelli di picco / *Display with bar graph with peak and hold function*
- Rilevamento dei picchi di pressione – Velocità di rilevamento 10 MS / *Pressure peak captured – 10ms scanning rate*

Codice / Ref.
SCJN-XXX-01-MPR

Scale disponibili dei manometri digitali: -1...16bar; 0...100bar; 0...400bar; 0...600bar; 0...1000bar

Available digital gauge ranges: -1...16bar; 0...100bar; 0...400bar; 0...600bar; 0...1000bar

Adattatore per manometro digitale, pressostato, sensore o trasduttore

Digital gauge, pressure switch, sensor or transducer adapter



Filetto 1 / Thread 1	Ch	Filetto 2 / Thread 2	H	PN [bar]	Codice/Ref.
Porta manometro connessione diretta, tenuta metallica / <i>Direct gauge adapter, metal sealing</i>					
M 16x2 *	22	ISO 228 G 1/4"	55	630	2014TR00
ISO 228 G 1/4" *	24	ISO 228 G 1/4"	33.5	630	2214PARG00

* Disponibili in acciaio inossidabile / *Available in Stainless steel*

2214PARG00: da digitale/sensore a manometro analogico
2214PARG00: from sensor/digital to analog gauge

Kit portatile prova pressione digitale

Pressure test digital kit

Valigetta completa di: / Box completed with: Dim. 385x255x90 mm	Codice / Ref.
2 Manometri digitali Service Junior + adattatore / <i>2 Digital gauge Service Junior + adapter (2014TR00)</i>	<p>CBOXMEDDS seguito dai 2 range di pressione scelti / <i>followed by the 2 chosen pressure ranges</i></p>
2 Adattatori per innesto rapido / <i>2 Quick coupling adapters</i>	
2 Adattatori maschio-maschio M16X2-M16X2 / <i>2 Adapters male-male M16X2-M16X2</i>	
1 Tubo M16X2- M16X2 lunghezza 2000mm / <i>1 hose M16X2- M16X2 length 2000mm</i>	
1 Adattatore femmina-maschio M10X1- 3/8"gas / <i>1 Adapter female-male M10X1- 3/8"gas</i>	
1 Adattatore femmina-maschio M10X1- 1/2"gas / <i>1 Adapter female-male M10X1-1/2"gas</i>	
1 Minipresa 1/4" gas / <i>1 Test point 1/4" gas</i>	
1 Minipresa 1/8" gas / <i>1 Test point 1/8" gas</i>	
1 Minipresa M8X1 / <i>1 Test point M8X1</i>	
1 Minipresa M10X1 / <i>1 Test point M10X1</i>	





SERVICEMAN PLUS*

- Funzionalità Plug & Play con riconoscimento automatico dei sensori, basta inserire il sensore desiderato e iniziare a misurare.
- Ampio display retroilluminato per una facile e rapida lettura anche in condizioni di luce scarsa.
- Diagnostica semplificata grazie alla memorizzazione dei valori MIN/MAX e alla visualizzazione diretta della pressione differenziale o della potenza idraulica.
- Guida all'uso semplice e chiara.

SERVICEMAN PLUS*

- "Plug & Play" using automatic sensor recognition, simply plug in and measure.
- Large back-lit display for quick and secure reading, even under difficult conditions.
- Simply troubleshooting using MIN/MAX memory and direct display of differential pressure or hydraulic performance.
- Simply and clear user prompts.



Sensori / Sensors



Flussometro / Flow meter

Kit Serviceman Plus	SCKIT-155-2-00-MP
Valigetta / Device Case	1
Parker Serviceman Plus con chiavetta USB, alimentatore, cavo di collegamento per PC e software SensoWin, CAN Bus: SCM-155-2-05-MP/ Parker Serviceman Plus incl. USB stick, power supply, PC connection cable and SensoWin software, CAN Bus: SCM-155-2-05-MP	SCM-155-2-05-MP
Cavo di collegamento CAN 2000 mm (maschio-femmina 5 pin) / Connection cable CAN 2000 mm (male-female 5 pin)	2
Ripartitore a Y CAN / Y-distributor CAN	1
Resistenza di chiusura CAN / Final resistance CAN	1
Adattatore (maschio - maschio M16x2) / Adapter (male-male M16x2)	2
Tubo flessibile di misurazione da 1500 mm (ambo i lati maschio M16x2) / Hose assembly 1500 mm (male M16x2 both ends)	2

* Disponibile in versione CAN Bus o analogica, eventuali sensori e flussometri da aggiungere al kit base.

* Available in CAN Bus or analogue version, sensors and flow meters to be added to basis kit.



Strumenti portatili prova pressione

Portable hydraulic instruments for pressure testing



Le valigette prova pressione sono predisposte per il collegamento tramite raccordi avvitabili standard M16x2 e tubo capillare flessibile.

I manometri sono a molla Bourdon con riempimento di liquido (glicerina (ph. 99.5% di origine vegetale).

Classe di precisione (sul valore di fondo scala):

Ø 100 mm precisione 1%. - Ø 63 mm precisione 1.6%.

Produzione secondo norma UNI EN 837-1.

Ogni kit è corredato di tubo capillare flessibile di mt 2 raccordato femmina 16x2 ambo i lati per connessione minipresa.

Per ogni valigetta è possibile scegliere il fondo scala di ogni singolo manometro in essa incluso.

Scale disponibili (bar): 0-16 - 25 - 40 - 60 - 100 - 160 - 250 - 315 - 400 - 600.

Per differenti necessità si prega di contattare il nostro ufficio commerciale.

Come ordinare: Si prega di scegliere il codice della valigetta prova pressione ed elencare le scale manometro desiderate. Per esempio:

CBOXMED3 25 160 315

The pressure test kits are made for connecting any hydraulic equipment with standard threaded test couplings M16x2 and fitted micro-hose.

Pressure gauges are fitted with a Bourdon spring and liquid filled (glycerine ph. 99.5% Vegetal origin).

Accuracy (of full scale value):

Ø 100 mm accuracy 1%. - Ø 63 mm accuracy 1.6%.

Production according to standard UNI EN 837-1.

Each kit is supplied with a hose assembly both ends female 16x2 (for test coupling connection) 2 meters long.

You can choose the scale of every single gauge included in a kit.

Available gauges ranges (bar): 0-16 - 25 - 40 - 60 - 100 - 160 - 250 - 315 - 400 - 600. For different requirements please contact our sales office.

How to order: Please choose the code of the pressure test kit and list the gauges required scales. For example:

CBOXMED3 25 160 315



3 manometri cassa acciaio inossidabile

3 pressure gauges stainless steel housing

diam. 63 mm
dim. 320x280xh119 mm

Codice/Ref.

CBOXMED3

Opzione: manometri con logo Mini Press e doppia scala Bar+PSI
Option: gauges with Mini Press logo and double scale Bar+PSI

CBOXMED3-M
CBOXMED3-M

4 manometri cassa acciaio inossidabile

4 pressure gauges stainless steel housing

diam. 63 mm
dim. 320x280xh119 mm

Codice/Ref.

CBOXMED4

Opzione: manometri con logo Mini Press e doppia scala Bar+PSI
Option: gauges with Mini Press logo and double scale Bar+PSI

CBOXMED4-M
CBOXMED4-M





7 manometri cassa acciaio inossidabile

7 pressure gauges stainless steel housing

diam. 63 mm

Opzione: manometri con logo Mini Press
Option: gauges with Mini Press logo

CBOXGRA7-M
CBOXGRA7-M

Codice/Ref.

CBOXGRA7



Kit portatile prova pressione componibile

Modular portable pressure test kit



Valigetta completa di: / Box completed with: Diam. 63 mm e/o 100 mm Dim. 385x255x90 mm	CBOXMEDS1
Microtubo raccor. F16x2-F16x2 L.2000mm / Fitted micro-hose F16x2-F16x2 L.2000mm	1
Portamanometro diretto 1/4" / Direct gauge connection 1/4"	1
Portamanometro 1/4" BSP / Gauge connection 1/4" BSP	1
Minipresa pistone 1/4" BSP / Poppet Valve Test point 1/4" BSP	1
Minipresa pistone 1/8" BSP / Poppet Valve Test point 1/8" BSP	1
Minipresa pistone 1/4" - 18NPTF / Poppet Valve Test point 1/4" - 18NPTF	1
Minipresa pistone M10x1 / Poppet Valve Test point M10x1	1
Minipresa pistone M14x1,5 / Poppet Valve Test point M14x1,5	1
Minipresa pistone 7/16" - 20UNF / Poppet Valve Test point 7/16" - 20UNF	1
Riduzione F M10X1 - M ISO228 G3/8" / Reducing adaptor F M10X1 - M ISO228 G3/8"	1
Riduzione F M10X1 - M ISO228 G1/2" / Reducing adaptor F M10X1 - M ISO228 G1/2"	1
Rubinetto esclusore attacco 90° / Anti-shock valve 90° entry	1
Rubinetto esclusore attacco diritto girevole / Anti-shock valve swivel direct entry	1

Opzione: manometri con logo Mini Press
Option: gauges with Mini Press logo

CBOXMEDS1-M
CBOXMEDS1-M





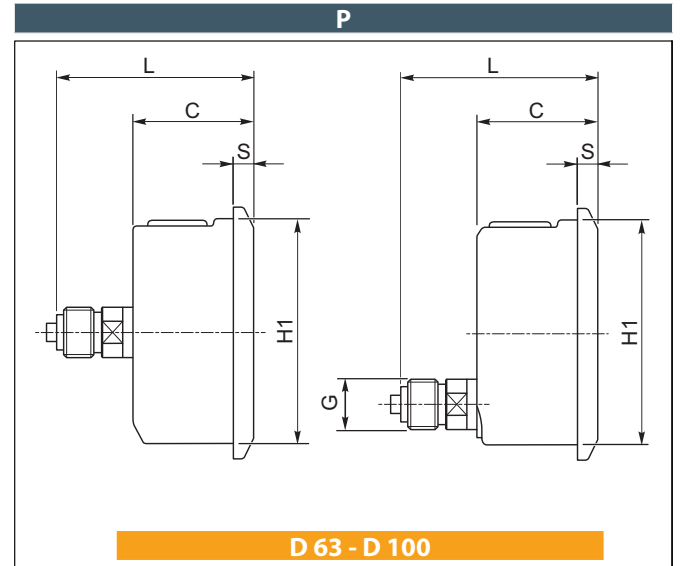
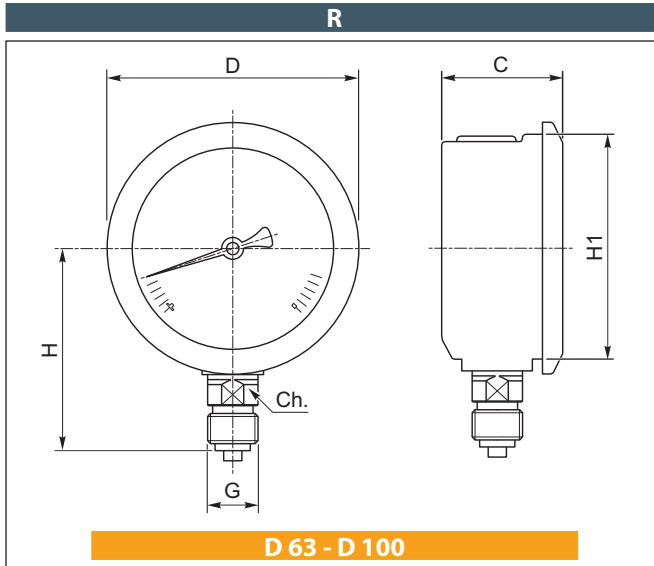

Manometri cassa acciaio inox con riempimento glicerina

Pressure gauges stainless steel case. Glycerine filled



	D	ISO228	H	H1	L mm	S mm	C mm	Ch mm	KI % F.S
D 63	63	G 1/4" A	54	62	56	6.5	32	14	1.6
D 100	100	G 1/2" B	87	100	81.5	8	48	22	1

D 63		
Scala / Range [bar]	Codice/Ref.	
		
-1...0	063.V01R	063.V01P
0...0.6	063.V06R	063.V06P
0...1	063.001R	063.001P
0...1.6	063.V16R	063.V16P
0...2.5	063.V25R	063.V25P
0...4	063.004R	063.004P
0...6	063.006R	063.006P
0...10	063.010R	063.010P
0...16	063.016R	063.016P
0...25	063.025R	063.025P
0...40	063.040R	063.040P
0...60	063.060R	063.060P
0...100	063.100R	063.100P
0...160	063.160R	063.160P
0...250	063.250R	063.250P
0...315	063.315R	063.315P
0...400	063.400R	063.400P
0...600	063.600R	063.600P
0...1000	063.M00R	063.M00P

D 100		
Scala / Range [bar]	Codice/Ref.	
		
-1...0	100.V01R	100.V01P
0...0.6	100.V06R	100.V06P
0...1	100.001R	100.001P
0...1.6	100.V16R	100.V16P
0...2.5	100.V25R	100.V25P
0...4	100.004R	100.004P
0...6	100.006R	100.006P
0...10	100.010R	100.010P
0...16	100.016R	100.016P
0...25	100.025R	100.025P
0...40	100.040R	100.040P
0...60	100.060R	100.060P
0...100	100.100R	100.100P
0...160	100.160R	100.160P
0...250	100.250R	100.250P
0...315	100.315R	100.315P
0...400	100.400R	100.400P
0...600	100.600R	100.600P
0...1000	100.M00R	100.M00P



I rubinetti esclusori sono normalmente utilizzati a protezione del manometro. Doppia funzione:
 - Smorzare lo shock della pressione in fase di apertura
 - Isolare lo strumento dalla linea in pressione
 Il dado girevole permette al manometro di essere orientato a piacimento e la presenza dell'OR al suo interno impedisce il trafileamento di fluidi tra il manometro e l'esclusore.

The gauge-isolator valves are normally used to protect the pressure gauge with a double function:
 - To dampen the pressure surge during the opening
 - To isolate the instrument from the system's pressure line
 The gauge can be oriented thanks to the rotating swivel nut and the internal o-ring here inserted prevents any fluid leakage between the gauge and the fitting.

Esclusore attacco diritto girevole

Gauge-isolator valve swivel straight connection

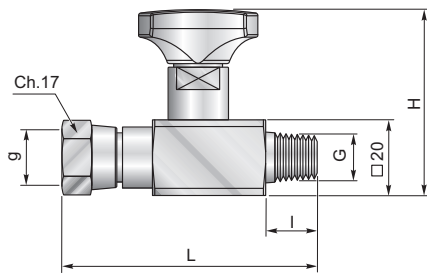

G	g	H	L	I	PN [bar]	Codice/Ref.
ISO 7/1 R 1/4" *	ISO 228 G1/4" #	46	60	14	400	ES180ZL
ISO 228 G1/4" 60°	ISO 228 G1/4" #	46	60	14	400	ES180G14ZL

#Tenuta per manometro con o-ring/
gauge sealing with o-ring

* Disponibili in acciaio inossidabile/ Available in Stainless steel

Esclusore attacco diritto doppia femmina girevole

Gauge-isolator valve double swivel straight connection

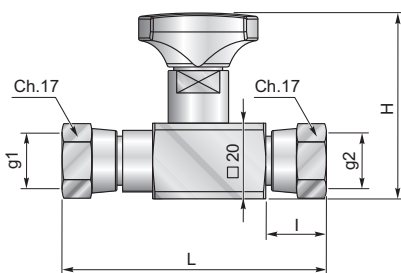

g1	g2	H	L	I	PN [bar]	Codice/Ref.
ISO 228 G1/4" *#	ISO 228 G1/4" #	46	62	16	400	ES18GZL
ISO 228 G1/4" #	ISO 228 G1/4" 60°	46	55.5	16	400	ES18GFZL

#Tenuta per manometro con o-ring/
gauge sealing with o-ring

* Disponibili in acciaio inossidabile/ Available in Stainless steel

Esclusore attacco diritto fisso

Gauge-isolator valve fixed straight connection

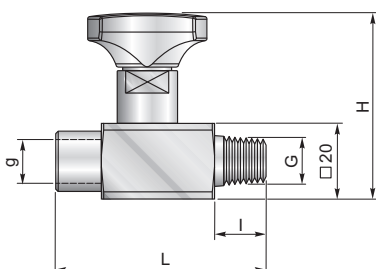

G	g	H	L	I	PN [bar]	Codice/Ref.
ISO 7/1 R 1/4"	ISO 228 G1/4"	46	58.5	14	400	ES18FZL
ISO 7/1 R 1/4"	ISO 7/1 R 1/4"	46	58.5	14	400	ES18FRZL
1/4" - 18 NPTF	1/4" - 18 NPTF	46	58.5	14	400	ES18FNZL



Caratteristiche generiche / General features



- Zincato superficialmente
- Identificazione produttore attraverso il logo
- Coppia di serraggio con manometro = 15Nm
- Superficially zinc-plated
- Manufacturer's identification through our logo
- Tightening torque with gauge = 15Nm

Esclusore attacco 3 vie

Gauge-isolator valve 3-way connection

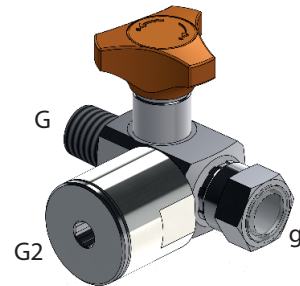

G	g	G2	PN [bar]	Codice/Ref.
ISO 7/1 R 1/4"	ISO 228 G1/4" #	ISO 228 G1/2"	400	ES180G12Z

#Tenuta per manometro con o-ring/
gauge sealing with o-ring

Esclusore attacco 90°

Gauge-isolator valve 90° connection

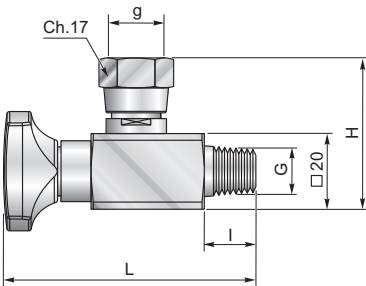

G	g	H	L	I	PN [bar]	Codice/Ref.
ISO 7/1 R 1/4" *	ISO 228 G1/4" #	40	68	14	400	ES090ZL
ISO 228 G1/4" 60°	ISO 228 G1/4" #	40	68	14	400	ES090G14ZL

#Tenuta per manometro con o-ring/
gauge sealing with o-ring

* Disponibili in acciaio inossidabile/ Available in Stainless steel

Esclusore attacco 90° doppia femmina girevole

Gauge-isolator valve 90° double swivel connection

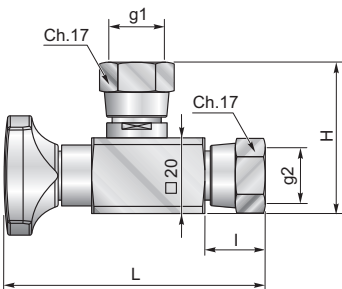

g1	g2	H	L	I	PN [bar]	Codice/Ref.
ISO 228 G1/4" *#	ISO 228 G1/4" #	40	68	16	400	ES09GZL
ISO 228 G1/4" #	ISO 228 G1/4" 60°	40	68	16	400	ES09GFZL

#Tenuta per manometro con o-ring/
gauge sealing with o-ring

* Disponibili in acciaio inossidabile/ Available in Stainless steel

Esclusore attacco fisso 90°

Gauge-isolator valve fixed 90° connection

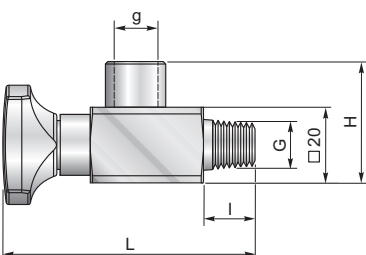

G	g	H	L	I	PN [bar]	Codice/Ref.
ISO 7/1 R 1/4"	ISO 228 G1/4"	40	68	14	400	ES09FZL
1/4" - 18 NPTF	1/4" - 18 NPTF	40	68	14	400	ES09FNZL



Gamma / Range	Caratteristiche / Features
16 LPM 30 LPM 60 LPM 120 LPM 180 LPM	Pressione 420 bar (6000 psi) / Pressure 420 bar (6000 psi) Classe di precisione 4% fsd / Accuracy within 4% fsd
200 LPM 300 LPM 400 LPM	Pressione 280 bar (4000 psi) / Pressure 280 bar (4000 psi) Classe di precisione 4% fsd / Accuracy within 4% fsd

I misuratori di portata sono progettati per rilevazioni continue o uso discontinuo.

L'ampio diametro di 63mm dello strumento di lettura analogico assicura controlli rapidi per monitorare le prestazioni di pompe idrauliche e per settare valvole di controllo del flusso.

Possono essere utilizzati su impianti idraulici fissi e mobili, ma anche su sistemi di lubrificazione e raffreddamento e su equipaggiamenti per l'erogazione di acqua e acqua-olio.

Per le loro caratteristiche i misuratori di portata possono essere utilizzati in condizioni avverse o in applicazioni dove non è possibile attingere all'energia elettrica.

Inoltre è possibile misurare la temperatura, tramite il termometro e la pressione, grazie alla predisposizione per la connessione con una minipresa da 1/4" G.

Flow indicators are designed for continuous monitoring or intermittent use commissioning.

The large clear 63mm diameter dial ensure that quick checks can be made to determine pump performance and setting of flow control valves.

They can be used on mobile and industrial hydraulic circuits. Also lubrication and coolant system using oil/water.

These direct acting flow indicators can be installed in hazardous areas or on applications where no power is available.

Moreover it is possible to check the temperature by the thermometer and the pressure by the predisposition for the connection with a 1/4" G test coupling.



Pressa pneumo-idraulica per microtubi
Pneumo-hydraulic crimping machine for microhoses

MINIPRESS
DIAGNOSTIC SYSTEMS



- A) POTENZA DI PRESSATURA: 100 Tonnellate
 - B) DIAMETRO MAX DI PRESSATURA: 46mm con set di morsetti
 - C) RANGE DI PRESSATURA (mm) : 6,5 - 30
 - D) APERTURA MORSETTI: +20mm
 - E) APERTURA SENZA MORSETTI: 59mm
 - F) DIMENSIONI: 200X300h.330
 - G) PESO: Kg. 24
 - H) SICUREZZA: Conforme alle norme CE
- Nonio graduato con spia luminosa per segnalare il diametro di pressatura raggiunto.

- A) SWAGING STRENGTH: 100 Tons
 - B) MAXIMUM CRIMPING DIAMETER: 46 mm including dies set
 - C) CRIMPING RANGE (mm): 6,5 – 30
 - D) MAXIMUM OPENING OF DIES SET: +20mm
 - E) MACHINE MAXIMUM OPENING WITHOUT DIES SET: 59mm
 - F) DIMENSIONS: 200X320Xh.330mm
 - G) WEIGHT: Kg. 24
 - H) SAFETY: Conforms To CE Standards
- Graduated vernier with control light indicating the achievement of the required crimping diameter.

La pressa è una macchina robusta e leggera, studiata per essere facilmente trasportabile sul posto di lavoro; ideale per la graffatura di tubi flessibili impiegati nei circuiti oleodinamici. Non necessita di particolare manutenzione, a parte una periodica lubrificazione.

Codice prodotto complete di set di morsetti per pressatura microtubi **RD2-3-4: O100M+6,5**

The machine is sturdy, lightweight and designed to be easily carried in work site; ideal for swaging hoses for hydraulic systems. It does not require any special maintenance, except for a periodic lubrication.

*Item part number complete with set of clamps to crimp **RD2-3-4 micro hoses: O100M+6,5***

MINI PRESS s.r.l.

40056 VALSAMOGGIA (BO) - ITALY

LOC. CREPELLANO - VIA G. DI VITTORIO 1 - 3

TEL. +39,051.6869070 . FAX +39,051.977842 . INFO@MINIPRESS.IT . WWW.MINIPRESS.IT